

AISC E&R Library UCB/SEM
7559

REPORT NO.
UCB/SEMM-90/23

STRUCTURAL ENGINEERING,
MECHANICS AND MATERIALS

1415
key words -
1- shear tabs
2- bolted web
connections

DESIGN OF SINGLE PLATE SHEAR
CONNECTIONS WITH SNUG-TIGHT
BOLTS IN SHORT SLOTTED HOLES

by

KEITH A. PORTER

ABOLHASSAN ASTANEH-ASL

DECEMBER 1990

DEPARTMENT OF CIVIL ENGINEERING
UNIVERSITY OF CALIFORNIA AT BERKELEY
BERKELEY, CALIFORNIA

RR1415
7559

01551

DESIGN OF SINGLE PLATE SHEAR CONNECTIONS
WITH SNUG-TIGHT BOLTS IN SHORT SLOTTED HOLES

by

Keith A. Porter, Graduate Research Assistant

and

Abolhassan Astaneh-Asl, Associate Professor

Department of Civil Engineering
University of California, Berkeley

DECEMBER 1990

ACKNOWLEDGEMENTS

This report is based primarily on a CE-299 report submitted in partial fulfillment of the requirements for the Master of Engineering degree of the first author from the Structural Engineering, Mechanics and Materials group of the Department of Civil Engineering, the University of California at Berkeley.

The authors thank Professor C. Thewalt of the University of California for taking the time to review this report, and the American Institute of Steel Construction for their partial sponsorship of this research project.

The plates for shear connection specimens were fabricated and supplied by the W & W Steel Company of Oklahoma City. The support of Ted Winneberger in this respect is sincerely appreciated.

The tests reported here were conducted in the laboratories of Department of Civil Engineering through partial support of the Department. Thanks are due also to Roy Stephens and William Mac Cracken for their assistance in performing the experimental work.

ABSTRACT

K. A. Porter and A. Astaneh-Asl

The main objective of this study was to determine the effects short slotted holes on the behavior and design of single plate shear connections. The American Institute of Steel Construction recently adopted a new design procedure developed at the University of California at Berkeley. The experimental work upon which the new procedure was based consisted of tests and analysis of single plate framing connections with tightened bolts in standard round holes. This study shows that the new design procedures were overly conservative where snug-tight bolts and short slotted holes were used.

The experimental part of the study consisted of four tests on full-scale connection assemblages using the testing setup and testing procedure used in the previous University of California research on single plate framing connections. A combination of shear and rotation are applied to the assemblages, to simulate beam tip behavior in a simply-supported beam continuously loaded to the formation of a plastic collapse mechanism at the beam midspan.

The study included review of past research on the single plate framing connection. Details of the experimental program used in this study are presented, followed by the experimental

01524

results. Also presented are analyses of the data produced, in the light of limit states and rotational flexibility. A modification to the existing single plate framing connection design procedure is proposed to account for this added flexibility. The added efficiency resulting from the use of snug-tight bolts in short slotted holes is also assessed.

The summaries and conclusions that were drawn from the study, the proposed design procedure modifications, a design example and allowable shear capacity tables that can directly be used in design are presented.

01555
55555

TABLE OF CONTENTS

1.	INTRODUCTION	
1.1	Background	1
1.2	Literature Review	6
1.3	Scope of the Research	11
2.	EXPERIMENTAL PROGRAM	
2.1	General	13
2.2	Semi-empirical Testing Approach	13
2.3	Parameters Affecting Behavior	14
2.4	Test Specimens	15
2.5	Type of Loading	17
2.6	Test Set-up	21
2.7	Instrumentation	22
2.8	Test Procedures	23
3.	EXPERIMENTAL RESULTS	
3.1	General	24
3.2	Plate Material Coupon Tests	24
3.3	Three-bolt Specimen	25
3.4	Five-bolt Specimen	26
3.5	Seven-bolt Specimen	27
3.6	Nine-bolt Specimen	29
4.	ANALYSIS OF RESULTS	
4.1	General	32
4.2	The Single Plate Framing Connection with Standard Holes	33
4.3	Rotational Stiffness Behavior	34

4.4	Point of Inflection	36
4.5	Strength	38
4.6	Bolt Group Efficiencies	51
5.	PROPOSED DESIGN PROCEDURE REFINEMENTS	
5.1	General	52
5.2	Proposed ASD Procedure Refinements	53
5.3	Application to Design Problem	54
6.	CONCLUSIONS	
6.1	General	57
6.2	Conclusions	58
	REFERENCES	60
	FIGURES	62
	APPENDIX A: EXPERIMENTAL DATA	80
	APPENDIX B: MATERIAL PROPERTIES	87
	APPENDIX C: DESIGN TABLES	89
	APPENDIX D: TEST SUMMARY SHEETS	96

01557
75510

LIST OF TABLES

Table C-1:	Design tables for 2-bolt and 3-bolt connections
Table C-2:	Design tables for 4-bolt and 5-bolt connections
Table C-3:	Design tables for 6-bolt and 7-bolt connections
Table C-4:	Design tables for 8-bolt and 9-bolt connections

85518

LIST OF FIGURES

- Figure 1-1: Typical applications of single plate shear connections
- Figure 2-1: Three-bolt test specimen
- Figure 2-2: Five-bolt test specimen
- Figure 2-3: Seven-bolt test specimen
- Figure 2-4: Nine-bolt test specimen
- Figure 2-5: Shear-rotation curves of typical beams
- Figure 2-6: Shear-rotation curve used for this project
- Figure 2-7: Test set-up used in the investigation
- Figure 2-8: Instrumentation
- Figure 3-1: A view of three-bolt specimen
- Figure 3-2: A view of three-bolt specimen
- Figure 3-3: A view of seven-bolt specimen
- Figure 3-4: Shear yielding of specimen with 7 bolts
- Figure 3-5: Specimen with 7 bolts at the end of test
- Figure 3-6: Hole deformations in 7-bolt specimen
- Figure 3-7: Start of shear yielding in 9-bolt specimen
- Figure 3-8: Considerable shear yielding of 9-bolt specimen
- Figure 3-9: 9-bolt specimen at the end of test
- Figure 4-1: Moment-rotation behavior of 3-bolt specimen
- Figure 4-2: Moment-rotation behavior of 5-bolt specimen
- Figure 4-3: Moment-rotation behavior of 7-bolt specimen
- Figure 4-4: Moment-rotation behavior of 9-bolt specimen
- Figure 4-5: Rotational stiffness behavior of 3-bolt specimen

01559

Figure 4-6: Rotational stiffness behavior of 5-bolt specimen
Figure 4-7: Rotational stiffness behavior of 7-bolt specimen
Figure 4-8: Rotational stiffness behavior of 9-bolt specimen
Figure 4-9: Reaction eccentricity behavior of 3-bolt specimen
Figure 4-10: Reaction eccentricity behavior of 5-bolt specimen
Figure 4-11: Reaction eccentricity behavior of 7-bolt specimen
Figure 4-12: Reaction eccentricity behavior of 9-bolt specimen
Figure 4-13: Eccentricity of point of inflection
Figure A-1: Load path for 3-bolt specimen
Figure A-2: Load path for 5-bolt specimen
Figure A-3: Load path for 7-bolt specimen
Figure A-4: Load path for 9-bolt specimen
Figure A-5: Normalized moment versus rotation for 3-bolt specimen
Figure A-6: Normalized moment versus rotation for 5-bolt specimen
Figure A-7: Normalized moment versus rotation for 7-bolt specimen
Figure A-8: Normalized moment versus rotation for 9-bolt specimen
Figure A-9: Normalized shear-moment behavior for 3-bolt specimen
Figure A-10: Normalized shear-moment behavior for 5-bolt specimen
Figure A-11: Normalized shear-moment behavior for 7-bolt specimen
Figure A-12: Normalized shear-moment behavior for 9-bolt specimen
Figure B-1: Coupon Test #1
Figure B-2: Coupon Test #2

CHAPTER 1

INTRODUCTION

1.1 Background

Single plate framing connections, also called shear tabs, are popular, inexpensive, easy to design, fabricate and erect, and relatively simple in behavior. The variety of connections in this class have in common a single plate which is welded to the support and bolted to the beam. The support can take a variety of forms, including a steel column, a steel beam, or a reinforced concrete wall. Figure 1-1 presents typical configurations.

A new allowable stress design procedure for the single plate framing connection appears in the 9th Edition of the AISC-ASD Manual (AISC 1989). The procedure is based on the research of Astanteh, Call and McMullin (1989) of the University of California- , Berkeley, who investigated the behavior of single plate framing connectors with standard punched holes and tightened bolts. That study did not include an investigation into the behavior of the connection with short slotted holes or snug-tight bolts, and was limited to connections with seven or fewer bolts. However, a number of professionals and researchers subsequently expressed interest in single plate framing

connections which could accommodate more shear and take advantage of the added construction tolerances afforded by the use of short slotted holes. The present study was intended to extend the current procedure to connections with up to nine snug-tight bolts in short slotted holes, and to determine the effects of these modifications on connection flexibility, weld efficiency, and bolt efficiency.

Like the work on the standard hole connection, this study relies on both experiment and analysis. The experimental and analytical regimes run closely parallel to the work for the existing design procedure, with the intention of producing a design procedure which is as consistent as possible with the existing one, while still taking into account the distinct behavior the short slotted holes produce in the connection.

The single plate framing connection has been shown to behave quite flexibly in rotation, and thus has been characterized as a shear connection. Like other shear connectors such as the standard hole single plate shear connection, the double angle framing connection, and the tee framing connection, the subject connection must simultaneously satisfy strength and ductility requirements. It must provide adequate strength to transfer beam end shear to the support, while supplying the rotational ductility required to accommodate beam tip rotations which develop through the performance life of the beam. That is to say, the single plate framing connection with short slotted holes must be able to reliably accommodate the shear and rotation

corresponding to beam plastic hinging at the midspan. The standard hole single plate shear connection was shown to meet these requirements.

Tests indicated that behavior was governed primarily by shear stresses, with moment effects on the framing connection minimal at the outset of loading, and reducing as loading and rotation increased. Shear yielding of the plate gross area and local yielding around the bolt holes in both framing connection and beam tip rapidly released moment to the beam midspan; as the loading approached ultimate, the connection behavior approached that of an ideal simple support.

The ideal simple support would transfer pure shear at the bolt line; the single plate framing connection was shown to transfer shear either at the bolt line for shallower connections, or within 4" of the bolt line for deeper connection. It was shown that the plate could be designed for pure shear, and that the bolts and welds could be designed for shear and moment, where the moment could be calculated according to simple rules.

The experimental work for this study follows the previous work on single plate shear connections with standard holes, in that beam end shear and rotation effects were assumed to control demand on the connection. Each specimen was subjected to shear forces and rotations which realistically would occur in an actual structure when a beam is slowly, monotonically, uniformly loaded until a plastic mechanism forms at the beam midspan. Beam collapse is not considered to occur simultaneously with

significant lateral loading, and so axial forces were not imposed on the connection. Nor was high axial loading with low shear and rotational- loading considered in the experimental work; a beam supported by this type of connection would not realistically appear intended as an element in a lateral force resisting system.

This investigation was performed to obtain specific information on the actual behavior of the single plate framing connection with snug-tight bolts in short slotted holes and to determine, experimentally, appropriate modifications to the existing design procedure recently adopted by the AISC. The suite of experiments consisted of conducting four full-scale tests of single plate beam-column assemblages. One experiment each on a three-bolt, five-bolt, seven-bolt, and nine-bolt connection was performed.

As with the previous work on the standard hole connection, the design procedures developed and presented here are based on the actual behavior and limit states of the single plate framing connections that were tested. The emphasis of this research was threefold: first, to parallel as closely as possible the experimental and analytical work performed on the standard hole connection, so that results would be directly comparable and so that any resulting design procedure modifications could be as minimal as possible; second, to verify that the use of short slotted holes would not materially reduce the connection's shear capacity through bolt hole failure; and third, to determine to

what extent, if any, the short slotted holes increased the connection's rotational flexibility. A significant increase in rotational flexibility could validate appropriate increases in the bolt group efficiency used in design, thus reducing the number of bolts required to carry a given shear and extending the usefulness of the single plate framing connection to deeper, longer-span beams.

The same test set-up used in the research on the standard hole connection was used in these tests (Astaneh, Call, and McMullin, 1989). It permits simultaneous controlled application of shear and rotation. Furthermore, the shear-rotation relationships applied in the research on the standard hole framing connection were applied to the current test specimens. These relationship were developed to model the behavior of a realistic range of simply-supported beams uniformly loaded to the formation of a plastic collapse mechanism. Beam tip shear and rotation were monitored and recorded. The beams modeled ranged from relatively short and stiff, with span-to-depth ratios as low as 4, to relatively long and flexible, with span-to-depth ratios as high as 38. The behavior of a beam with a span-to-depth ratio of 25 was considered adequately representative of the range, and adequately conservative, imposing relatively high rotation demand on the connection at ultimate shear. The shear-rotation relationship for this beam was modeled as a trilinear curve, with elastic, inelastic, and strain-hardening behavior characterizing the segments.

01565

1.2 Literature Review

The authors performed the literature review seeking direction on three issues: first, what had previous researchers identified as the connection's dominant performance parameters? Second, how had they synthesized field conditions in the laboratory, and what behavior had they observed? And third, what logic had they followed in translating the observed behavior into connection design recommendations?

White performed tests on single plate framing connections with 2 to 4 bolts at Cornell University (White, 1965) during a study on framing connections for square and rectangular structural tubing. He imposed moment and rotation on test specimens with low concurrent shear, and then tested connections in essentially pure shear. He observed various failure modes, including local buckling in the support, web crippling of the connected beams, excessive beam web bearing deformations around the bolt holes, and weld tearing.

In research at the University of British Columbia, Vancouver, Lipson (1977) studied single angle connections welded to a column and bolted to a beam. The bolts were fully tightened. Lipson attempted to model realistic behavior in an actual structure by applying combined shear and rotation on the connection with a short length of beam connected at one end to a support with a sample connection. The beam was loaded with two actuators: one near the connection for the application of shear, and one several feet from the support for the application of

01566

rota-tion. A linear shear-rotation relation was applied to the beam to model the effects which the connection would experience up to beam and connection yield conditions. At yield, he locked (or slightly reduced) rotation and continued to apply shear until the connection failed. He observed three failure modes: shear fracture of all bolts; shear fracture of all upper bolts accompanied by the bottom bolt tearing through the plate; and excessive deformation of the bottom bolt hole. He observed that moment increased with connection depth, but that in smaller connections (fewer bolts) the sense of moment at the bolt line could reverse sign at high rotation, from that causing tension at the top of the connection to that causing compression at the top of the connection. He observed that this phenomenon was occasioned by displacement of the beam web with respect to the angle, and might be accentuated by imperfect alignment of beam and angle bolt holes. Lipson concluded that the bulk of the connection flexibility came from slip rotation of the beam with respect to the angle, rather than through deformation of the angle itself.

Researchers at the University of Arizona, Tucson, (Richard, Gillett, Kriegh, and Lewis, 1980) developed an analytical model to predict moment-rotation relationships for single plate framing connections with standard holes and tightened bolts, using inelastic finite element analyses that used experimentally-determined bolt-deformation relations. They then experimentally verified the model with stub beam tests and full-scale beam

tests. In the full-scale beam tests, they loaded a beam to its midspan yield stress and verified the predicted connection moment-rotation relationship on the connection. They defined bolt line eccentricity as the ratio of moment at the bolt line to connection shear. Their full-scale beam tests verified the bolt line eccentricities the model predicted at loads as high as 1.5 times allowable. They did not test the full-scale connection to failure.

They produced a design procedure which considered shear effects on bolts, and moment and shear effects on the plate and weld. They recommend connection design with reference to shear and moment effects at the point of 1.5 times allowable load levels. Their data indicate that bolt line moments climbed rapidly with rotation at first, but the rotational stiffness (which the slope of the moment-rotation curve represents) dropped to relatively stable positive values when loads reached and exceeded yield. Because these positive values were quite low compared with their initial moment-rotation slope, the University of Arizona researchers concluded that the moment versus rotation curve was essentially flat, and moment might be considered independent of rotation beyond yield.

In later work, researchers at the University of Arizona, Tucson, (Hormby, Richard, and Kriegh, 1984) tested similar connections with short slotted holes and concluded that, at loads up to 1.5 times allowable, tightened A325 and A490 bolts behave essentially the same in round or short slotted holes, as a result

of the clamping action of the high strength bolts. Thus the University of Arizona researchers found that the earlier model was useful for estimating the rotational stiffness behavior of single plate framing connections with short slotted holes and tightened bolts.

Pillinger (1988) provided a summary of recent design provisions used in Great Britain. In those procedures, more than one line of bolts is permitted, and shear is assumed transferred through the bolt group centroid. Thus the bolts are designed for shear only, and the plate, weld, and support are designed for shear and resulting moment. Rotational flexibility is assumed to be provided only by the bolt slip in 2mm tolerance holes (slightly larger than standard holes) and by local yielding of the plate. Pillinger recommended that minimizing plate depth will maximize connection flexibility. He also recommends that the connection should provide at least 15mm (about 9/16") clear between the beam and support to ensure that the beam web clears the fillet welds and to allow for maximum beam tip rotations. This recommended minimum would in general allow less than 0.027 radians of beam tip rotation before the bottom flange bore against the support, given rotation about the bolt group centroid and reasonable spacing of bolts.

Researchers at the University of California, Berkeley, extended Lipson's test procedures and applied them to tee framing connections (Astaneh, 1987) to double angle framing connection (McMullin and Astaneh, 1988) and to single plate framing

connections with standard holes, (Astaneh, Call and McMullin, 1989). In these tests, the experimenters applied shear and rotation to model beam behavior to yield, plastic hinge formation, and strain hardening. In the single plate framing connections studies, the researchers tested a number of connections beyond the first limit state of gross section yielding, until the connection collapsed. The University of California, Berkeley research differed from previous work in three respects: the load line was extended to model inelastic and plastic beam behavior, the plate was designed for shear effects only, and bolts were designed for moment effects as well as shear effects. At the loads levels which previous investigators had applied, the connections behaved similarly to those tested in earlier work. At loads beyond the factored beam line, it was observed that bolt line eccentricities dropped, and stabilized at levels below those described in the University of Arizona research.

As the earlier tests indicated, rotational stiffness in the single plate shear connection started high, but dropped as loads reached yield. Moment increased fairly slowly with shear, and the eccentricity dropped to a fairly constant level as shear levels exceeded the calculated plate gross section shear yield. The difference between the observations on the earlier experiments and the University of California, Berkeley observations, was the level of the final eccentricity. Previous researchers had studied connection behavior at loads up to 1.5 times allowable, based on specified strengths. The University of

California researchers had studied connection behavior at loads exceeding plate shear yield, where shear yield was based on coupon tests of the plate material, which are generally somewhat higher than specified. Loading continued until the connection collapsed. The University of California researchers observed final eccentricities at higher load levels, closer to ultimate, than had previous researchers. The conclusions following from these observations could be based on true ultimate strength states, rather than the lower, specified allowable stress states.

Using a linear rule relating observed weld line eccentricity to number of bolts, the University of California, Berkeley researchers produced simple design procedures relating weld line and bolt line moments to number of bolts. The researchers considered six limit states in the design procedure: plate yielding, plate net section shear fracture, bolt fracture, weld fracture, edge distance fracture, and bearing failure of bolt holes. The procedure forced the preferred failure mode, shear yielding of the gross section, through control of the factor of safety for six identified failure modes.

1.3 Scope of the Research

The main objective of this study was to adapt current AISC design procedures for single plate shear connections with tightened bolts in standard holes (AISC, 1989), for use with the single plate shear connection with snug-tight bolts in short slotted holes. The specific objectives were:

1. Obtain experimental data on the realistic behavior and shear strength of the single plate framing connection with short slotted holes and snug-tight bolts;
2. Determine to what extent the use of snug-tight bolts in short slotted holes increases connection rotational flexibility; and
3. Determine any other differences in behavior or limit states produced by the use of snug-tight bolts in short slotted holes.

572

CHAPTER 2

EXPERIMENTAL PROGRAM

2.1 General

Four full-scale beam-to-column assemblages were tested. They represented a range of connections following the material and geometric requirements stated in the existing single plate framing connection design procedures of the 9th Edition of the AISC-ASD manual. The connections used snug-tight bolts in punched short slotted holes. The beam web had standard drilled holes. The main purposes were to determine the effects on rotational stiffness of using snug-tight bolts in short slotted holes, to determine any other behavioral characteristics might distinguish this connection from its tightened bolt, standard hole cousin, and to determine if the connection can accommodate nine bolts.

2.2 Semi-empirical Testing Approach Used

Currently two approaches are followed in developing design procedures. One approach, which is purely empirical, is to conduct a number of experiments and use numerical techniques to fit appropriate empirical design equations to test results. The

approach relies almost entirely on test results, and thus producing reliable design rules requires data from a large number of tests. This study followed a second approach, which was to develop design rules based on basic theory and fundamental concepts of mechanics of materials. Experiments were conducted to provide behavior data which theory could not predict. In this study, the primary parameters which theory alone could not provide were the rotational stiffness behavior of the connection, and the failure modes. Behavior similar to that of the standard hole connection, but possibly more flexible, was expected, but the magnitude of any additional flexibility was unknown.

2.3 Parameters Affecting Behavior

The main parameters affecting the behavior of single plate framing connections are:

- a. Plate geometry and material;
- b. Number, size, type, and installation requirements of bolts;
- c. Bolt hole geometry and method of fabrication (drilled or punched);
- d. Weld size, type of electrode used and method of welding;
- e. Behavior of the connected beam as well as of the supporting element; and
- f. Type of loading and its method of application.

Items (a) through (e) are dealt with in Section 2.4, Test

01574

Specimens. Type of loading is discussed in Section 2.5. The test set-up used to apply the loading is discussed in section 2.6. The instrumentation used to acquire the data is discussed in Section 2.7.

2.4 Test Specimens

The test assemblages comprised an approximately five-foot length of beam bolted to a single plate framing connection, which was welded to a short length of column approximately three feet long. Connections tested included a three-bolt, a five-bolt, a seven-bolt, and a nine-bolt specimen.

2.4.1. Connection:

The existing design procedure for the standard hole connection specifies the following parameters for the connection:

1. Single bolt row, 2 to 7 bolts

(Because bolt ductility contributes to connection ductility, it was considered prudent to use A490 bolts in the current study. A490 bolts exhibit lower ductility than A325 bolts, and thus represent the extreme case. Further, researchers and practitioners have expressed interest in connections with greater shear capacity, so a test using 9 bolts was performed in addition to tests on 3-bolt, 5-bolt, and 7-bolt connections. The bolts were 3/4 inch diameter. The plate bolt holes were punched short slotted; the beam web bolt holes were drilled round. Nominal diameters were 13/16

inch.)

- 2. Bolt pitch = 3 inches
- 3. Vertical edge distance = 1.5 inch
(In these tests, a vertical edge distance of 1.5 times the bolt diameter was used, which represents a more extreme case.)
- 4. Distance from the weld line to the bolt line = 3 inch
- 5. Shear plates have F_y of 36 ksi
- 6. Fillet welds are E70XX electrodes
(Welds in this study were done by Gas Metal Arc Welding (GMAW) with wires equivalent to E70XX electrodes. Weld size was 1/4 inch for all specimens, which is approximately 3/4 times the plate thickness.)
- 7. Plate thickness $t \leq 1/2$ (bolt diameter) + 1/16 inch
(Plate thicknesses here were 3/8 inch.)
- 8. Plate length $L \geq 1/2$ the distance from the weld line to the bolt line.

The test specimens are shown in Figures 2-1, 2-2, 2-3, and 2-4. The single plates used as test specimens were fabricated by a major steel fabricator and sent to the University of California. The fabricator punched the short slotted holes. The plates were welded to the column in the laboratory.

2.4.2. Beam:

Significant ductility in this connection derives from deformation of the beam web bolt hole. **Grade 50 steel beams were**

91576

used to control this effect and test the limiting case. The three-bolt and five-bolt specimens were tested using a W18x55. The seven-bolt specimen was tested using a W24x84 section. A W30 section was used for the nine-bolt specimen. The beam web holes were standard round holes with a nominal diameter of 13/16 inch, and were drilled in the laboratory.

2.4.3. Column:

In his tests on single plate framing connections welded to tube section columns, White observed that significant flexibility derived from deformation of the tube wall. To limit this effect and test the more critical case, the framing connections in the current study were welded to the column flange opposite and offset from the column web. The offset was provided so that the beam web and column web aligned. The column section used in these experiments was W10x77.

2.5 Type of Loading

It was reasoned that the primary effects the connection experiences from the beam are shear and rotation. Two steps were involved in establishing a loading curve for a given connection: first, to establish a relationship between shear and rotation at the tip of a generic beam; second, to determine a rule for associating a connection size with a beam size. The first step was accomplished through analytical study of beam behavior; the second step was accomplished by making an assumption linking

91577

connection shear capacity and beam tip shear.

The shear-rotation history developed by Astaneh (1987, 1989) was used for these experiments. It uses a trilinear curve to represent the shear and rotation effects at a simple support of any standard beam of given length, uniformly loaded to plastic collapse through the formation of a plastic hinge at the midspan.

Astaneh used a computer program to simulate a beam, supported by flexible connections, and uniformly loaded until the beam collapsed. End shear and rotations were recorded as loading progressed. Astaneh analyzed all cross-sections from W16 to W33 that are listed in the AISC Manuals (1980, 1989 and 1986). In the analysis, spans of 10 feet, 30 feet, and 50 feet were considered for all beams. The material considered was A36 steel. These analytical studies indicated that end shear versus end rotation for these beams and spans are very stable and vary slightly with change of shape factor f , where f is equal to Z_x/S_x , the ratio of plastic section modulus to elastic section modulus. Figure 2-5 shows two curves representing the shear-rotation values for two extreme cases: a shallow beam with large span and a deep beam with short span. For other cases, the curves fell between these two curves. The shear-rotation curve that was selected and used in testing corresponded to a beam span-to-depth ratio of 25 for A36 material beams. This would also compare with a span-to-depth ratio of 18 for beams with 50 ksi yield stress. In actual structures the ratio rarely exceeds 25.

As the curves in Figure 2-5 indicate, the shear rotation relationship follows an elastic path until yielding starts at the beam midspan. Rotation begins to increase more rapidly with increasing shear, as yielding spreads toward the neutral axis of the beam midspan. The curves were developed assuming elastic-perfectly-plastic behavior. In actual beams, strain hardening would provide additional strength, as indicated by the dotted lines in Figure 2-5.

The loading history selected to apply to the test specimens is shown in Figure 2-6. Also shown in the figure are two dotted lines representing the two extreme cases of shear-rotation demand as discussed above.

Segment AB on the loading curve corresponds to the elastic behavior of the beam. At point B, the midspan cross-section of the beam reaches M_y and the extreme fiber at the beam midspan yields. Beam tip rotation is 0.02 radians. Segment BC on the plot represents the region of inelastic behavior of the beam where yielding progressively penetrates the beam midspan cross-section. Point C represents the formation of a plastic hinge at the beam where moment is M_p . Segment CD represents beam strain hardening. Point D corresponds to the ultimate moment capacity at the beam midspan, while end rotations have reached 0.10 radians.

To establish the beam end shear corresponding to each of these points, it was assumed that the beam material was A36. This material rarely yields as low as 36 ksi, so the yield

stress for the beam was assumed to be the same as that of the plate. Coupon tests were performed on the plate material before the connections were tested. The results of these coupon tests are presented in Appendix B.

The second step in determining an appropriate load path for a particular connection was to make an assumption linking connection shear capacity and beam tip shear: the plate should experience gross section shear yield when the beam midspan reaches plastic moment at the midspan. Gross section shear yield capacity of a plate with thickness t , length L , and yield stress F_y , was denoted R_y , and was calculated as $0.6 \times F_y \times t \times L$. Point C on the load path corresponded to a connection shear of R_y and rotation 0.03 radians. Point B was established at 0.02 radians rotation. The shear corresponding to point B (denoted as R_{yy}) is equal to the shear at point C (denoted R_y) divided by the shape factor f of the beam cross section. A shape factor of 1.12, which is typical of W sections, was used for f . Thus point B was established at 0.02 radians and $R_y/1.12$. Point D corresponds to beam midspan ultimate moment, and thus is related to point C by the ratio of ultimate stress to yield stress. Shear at point D was calculated as $R_y F_u/F_y$. The rotation at point D was established as 0.10, or five times beam end rotation at midspan yield.

2.6 Test Set-up

Two set-ups could realistically simulate the true behavior of a beam supported by this type of simple support. The first set-up would be a full-scale beam provided with connections and supports, uniformly loaded until it collapsed. This would have been expensive. This study used a second option, developed by Astaneh (1987, 1990) and similar to Lipson's (1977), where a full-scale connection was fabricated, welded to a short section of column, and bolted to a short length of beam. The column was bolted to a reaction block. Figure 2-7 shows the test set-up. Two actuators were attached to the beam segment, one to apply shear about a foot from the column, (denoted actuator S in the figure) and one to control rotation, (denoted actuator R in the figure) about five feet from the column. Actuator S was force controlled, and supplied the bulk of the shear. Actuator R was displacement controlled. Both actuators were instrumented to record their load and displacement. The shear load on the connection was thus the sum of the loads applied by the actuators. The beam tip rotation was calculated as the difference in actuator displacements, divided by the distance between them. Since beam shear between the actuators was low, the effect of beam bending on calculated beam tip rotation was negligible.

2.7 Instrumentation

The instrumentation used in these tests are shown in Figure 2-8. They included one load cell and one Tempesonic displacement transducer in each actuator, two linear variable displacement transducers (LVDT) on both top and bottom beam flange, two more LVDTs on the single plate, three linear potentiometers along the beam bottom flange, and one linear potentiometer connected to the single plate. An IBM-PC-based data acquisition system was used to record and process instrument data as the tests progressed.

The instruments on the actuators were used to monitor actuator loads and displacements. Their data were collected by the data acquisition system, reduced to connection shear and rotation, and superimposed on the monitor of one the IBM-PCs over the image of the intended load path. The applied load path could be observed and controlled as the test progressed. The LVDTs on the beam flanges were used to verify beam tip rotation. The LVDTs on the single plate were used to derive rotation of the single plate. The difference between beam end rotation and plate rotation was the rotation resulting from bolt slip and deformation of the bolts and bolt holes. The linear potentiometers connected to the beam bottom flange recorded displacement at both actuators (to verify the data from the Tempesonics) and to record beam displacement at the bolt line. The linear potentiometer connected to the single plate recorded shear deformation at the bolt line.

2.8 Test Procedures

Each test was prepared and proceeded as follows:

1. The single plate was welded to the column flange, opposite and offset from the column web, so that the beam web and column web would align.
2. The column was bolted to the reaction block.
3. The beam was bolted to the connection, using snug-tight bolts. The bolts were hand tightened, tightened to snugness with a wrench, and then given a 1/6th additional turn with a wrench.
4. The instrumentation was installed, and the connection, whitewashed over the entire plate and weld.
5. The instrumentation calibration was checked, and a small load and rotation applied to the beam, to verify the proper operation of the set-up.
6. The shear-rotation history was applied to the connection in steps of between 5 kip and 10 kip increments, along with the corresponding rotation. Figure 2-9 is a photograph of the computer display during one of the tests. It shows both target and actual load line. During the test, data was collected at load step, and significant events were noted, recorded, and photographed. Videotape recordings were made of the three-bolt, seven-bolt and nine-bolt tests.

CHAPTER 3

EXPERIMENTAL RESULTS

3.1 General

The qualitative and quantitative test results are presented in this chapter. A summary of the behavior of each specimen is presented. The relevant plots of the experimental data are given in Appendix A. A summary sheet for each test is provided in Appendix D.

As discussed in Chapter 2, each test consisted of subjecting the test specimen to the shear-rotation history of Figure 2-10. The shears and rotations were monitored to ensure that the loading path followed that prescribed. The behavior of each specimen was observed, recorded and photographed.

3.2 Plate Material Coupon Tests

The material for each shear tab sample came from a single heat of A36 steel. Plate material from the same heat was subjected to two coupon tests. Average engineering yield stress was 43.6 ksi; average ultimate strength was 62.9 ksi. The material had exhibited a marked yield plateau and strain hardening curve typical of A36 steel. Average ultimate strain

was 0.290.

3.3 Three-bolt Specimen

The plate was $3/8$ in. x $8-1/4$ in. x $4-1/4$ in. The beam was a W18x55, with web thickness of 0.39 in. The material of plate was A36 and the beam, A572 Gr50. As discussed earlier, the load line was defined as trilinear. The elastic segment was defined between zero shear, zero rotation, and 69.5 kip shear, 0.02 radians rotation. The inelastic segment was defined between 69.5 kip shear, 0.02 radians rotation, and 77.9 kip shear, 0.03 radians rotation. The strain hardening segment was defined between 77.9 kip shear, 0.03 radians rotation, and 112.4 kip -shear, 0.10 radians rotation.

At 0.0189 radians rotation, shear yield patterns began to appear in the whitewash between the bolt line and the weld line. Also, yield patterns in the whitewash immediately below the bolts indicated local yielding in bolt bearing.

At 0.0204 radians rotation, shear yield patterns in the whitewash indicated shear yielding along almost the entire length of the plate between the bolt line and the weld line. No yielding patterns were visible in the whitewash within $1/2$ in. of the weld line. The plate had deformed visibly in shear.

At 0.0297 radians rotation, shear yield patterns in the whitewash indicated that the entire length of the plate between the bolt line and $1/2$ in. from the weld line had yielded in shear. Plate material had visibly bulged beneath the bolts, and

local yielding was indicated outside of the bolt line next to the middle bolt.

At 0.0565 radians rotation and 92.1 kip shear, the two top bolts fractured in shear and the bottom bolt sliced through the bottom of the plate. The beam top flange dropped down onto the top of the plate. The plate had deformed perhaps $3/8$ in. in shear. Flaked whitewash indicated that shear yielding extended from just outside the bolt holes to within $1/2$ in. of the weld line. The weld appeared to be intact. The bolts had deformed perhaps $1/32$ inch in shear. Figures 3-1 and 3-2 show views of connection and test set-up for this test.

3.4 Five-bolt Specimen

The plate was $3/8$ in. x $14-1/4$ in. x $4-1/4$ in. The beam was a W18x55, with web thickness of 0.39 in. The plate was A36 and the beam, A572 Gr50. As discussed earlier, the load line was defined as trilinear. The elastic segment was defined between zero shear, zero rotation, and 120.1 kip shear, 0.02 radians rotation. The inelastic segment was defined between 120.1 kip shear, 0.02 radians rotation, and 134.5 kip shear, 0.03 radians rotation. The strain hardening segment was defined between 134.5 kip shear, 0.03 radians rotation, and 194.1 kip shear, 0.10 radians rotation.

At 0.0178 radians rotation and 107 kip shear, shear yield patterns had appeared in the whitewash between the bolt line and the $1/2$ in. from the weld line along most of the plate length,

except for the top and bottom 1-1/2 in. Also, yield patterns in the whitewash immediately below the bolts indicated some local yielding from bolt bearing.

At 0.020 radians rotation and 120 kip shear, shear yield patterns in the whitewash indicated shear yielding along the entire length of the plate between the bolt line and about 1/2 in. from the weld line. The plate had deformed visibly in shear.

At 0.038 radians rotation and 151.9 kip shear, all five bolts fractured in shear. The beam top flange dropped onto the top edge of the plate. Flaked whitewash indicated that shear yielding extended from just outside the bolt holes to within 1/2 in. of the weld line (outside being the end farther from the weld). Flaked whitewash also indicated local yielding around the outer ends of the bolt holes. The plate had deformed about 3/8 in. in shear. The bolts had deformed about 1/32 inch in shear.

3.5 Seven-bolt Specimen

The plate was 3/8 in. x 20-1/4 in. x 4-1/4 in. The beam was a W24x84, with web thickness of 0.47 in. The plate was A36 and the beam, A572 Gr50. As discussed earlier, the load line was defined as trilinear. The elastic segment was defined between zero shear, zero rotation, and 171 kip shear, 0.02 radians rotation. The inelastic segment was defined between 171 kip shear, 0.02 radians rotation, and 191 kip shear, 0.03 radians rotation. The strain hardening segment was defined between 191 kip shear, 0.03 radians rotation, and 276 kip shear, 0.10 radians

rotation.

At 0.008 radians rotation and 68 kips shear, yield patterns suggesting bearing yielding had appeared in the whitewash immediately beneath the bolts, but not at the bolt hole ends.

At 0.019 radians rotation and 169 kips shear, shear yield patterns had appeared in the whitewash between the bolt line and about 1/2 in. from the weld line along the entire plate length. Also, yield patterns appeared in the whitewash at the outside ends of the top 4 bolt holes, with patterns suggesting bearing yielding down and away from the weld line.

At 0.030 radians rotation and 189.1 kip shear, all seven bolts fractured in shear. The beam top flange dropped onto the top edge of the plate. Flaked whitewash indicated that shear yielding extended from just outside the bolt holes to within 1/2 in. of the weld line (outside being the end farther from the weld). Flaked whitewash also indicated local yielding around the outer ends of the bolt holes. The plate had deformed perhaps 3/8 in. in shear. The bolts had deformed perhaps 1/32 inch in shear.

Figure 3-3 shows test specimen with 7 bolts at the beginning of test. Figures 3-4 shows the specimen at 0.019 radian rotation corresponding to beam end rotation when beam has just yielded at midspan. Notice the vertical and horizontal black lines on the whitewash between the bolt line and the weld line. These lines are the sign of shear yielding of the plate.

Finally, Figure 3-5 shows the connection when rotation is about 0.029 radian which is the end rotation of a beam when a

plastic hing is forming at midspan and beam is approaching plastic collapse. Notice the dark appearance of the shear tab which indicates extensive shear yielding of the plate which of course is consistent with objective of the design to have the plate reach yielding when beam reaches collapse load.

Figure 3-6(a) shows shear yielding of specimen when beam end rotation was 0.019 radian whic correspond to a beam midspan moment of M_y . Figure 3-6(b) shows the same specimen when rotation is 0.029 which corresponds to beam midspan moment of M_p .

3.6 Nine-bolt Specimen

The plate was 3/8 in. x 26-1/4 in. x 4-1/4 in. The beam was a W30. The plate was A36 and the beam, A572 Gr50. As discussed earlier, the load line was defined as trilinear. The elastic segment was defined between zero shear, zero rotation, and 221 kip shear, 0.02 radians rotation. The inelastic segment was defined between 221 kip shear, 0.02 radians rotation, and 248 kip shear, 0.03 radians rotation. The strain hardening segment was defined between 248 kip shear, 0.03 radians rotation, and 358 kip shear, 0.10 radians rotation. At 0.010 radians rotation and 111 kips shear, yielding was apparent beneath bolt holes, but not at ends.

At 0.0175 radians rotation and 193 kips shear, shear yield patterns had appeared in the whitewash between the bolt line and about 1/2 in. from the weld line, along the bottom 19 in. of plate length. Outside the bolt line, the top two bolts had

caused yielding at the ends of the bolt holes farthest from the weld line.

At 0.0243 radians rotation and 233 kips shear, shear yield patterns extended the length of the plate between the bolt line and about 1/2 inch from the weld line. A fracture about 1/8 inch deep had developed at the bottom of the plate, below the bottom bolt and slightly nearer the weld line.

At 0.0345 radians rotation and 250.8 kip shear, all nine bolts fractured in shear. The beam top flange dropped onto the top edge of the plate. Flaked whitewash indicated that shear yielding extended from just outside the bolt holes (the end of the holes farther from the weld line) to within 1/2 inch of the weld line, except for the top about 1 inch of plate. Except for the heat-affected zone and the top about 1 in. of plate between the bolt line and the weld line, almost the entire plate seemed to have experienced yielding. The heat affected zone, within 1/2 inch of the weld line, lacked indications of yielding. There was a fracture in the top of the plate 2 in. to 2-1/2 in. long just inside the weld line. It had not been observed before collapse, and might have been caused by the impact of the beam top flange on the plate top edge after the bolts sheared. However, the absence of shear yielding along the top about 1 in. of plate suggests that the fracture had developed prior to collapse, when shear yielding was still developing in the plate. The fracture beneath the bottom bolt had developed to 5/16 in. deep from the plate bottom toward the bottom bolt. The plate had deformed

perhaps 3/8 in. in shear. The bolts had deformed about 1/32 inch in shear.

Figures 3-7 shows the test specimen with 9 bolts at 0.01 radian rotation which corresponds to almost the end rotation of the beam under service load and Figure 3-8 shows the connection at 0.0243 radian corresponding to slightly more rotation than the beam end rotation when beam would just yield. Notice the vertical and horizontal black lines on the whitewash that are sign of shear yielding of the plate. Figure 3-9 shows the connection when rotation is about 0.031 radian which is about the the end rotation of a beam when a plastic hing is forming at midspan and beam is approaching plastic collapse. Notice the dark appearance of the shear tab which indicates extensive shear yielding of the plate which of course is consistent with objective of the design to have the plate reach yielding when beam reaches collapse load.

01591

CHAPTER 4

ANALYSIS OF RESULTS

4.1 General

In this research program, four samples of the single plate shear connections were designed in accordance with material and geometric requirements presented in the 9th Edition AISC-ASD Manual (1989). The holes in the plate were short slotted. The holes in the beam web were standard round. The bolts were snug-tight. The specimens were tested according to the same regime used to verify the standard hole design procedure. Essentially, the behavior of the single plate shear connection with short slotted holes was observed to differ from that of the standard hole connection only in the location of the point of inflection. The short slotted holes seem to make the connection behave more like a pure pin connection.

It was observed that plate gross section shear yielding governed the capacity of each specimen. Analysis according to LRFD methods confirms the plate shear yield mechanism governs plate shear capacity, but analysis according to ASD methods suggests that plate net section shear fracture would control plate shear strength. The specimens did not collapse when the gross area yielded, however. Failure occurred when the bolts

fractured in shear. Bearing failure was controlled by adequate plate thickness and adequate edge distance. Weld fracture was prevented by sizing welds to match or exceed plate shear capacity, using matching fillet welds on each side of the plate, with weld size 3/4 of plate thickness. Weld fracture or gross section shear fracture near the weld would be the only mechanisms that would result in catastrophic collapse of the connection. The following sections discuss these points in depth.

4.2 The Single Plate Framing Connection with Standard Holes

For consistency, these samples were designed in accordance with the material and geometric requirements of the Ninth Edition AISC-ASD Manual design procedure for single plate shear connections (AISC 1989). Those procedures were based on the University of California at Berkeley research work on single plate framing connections with standard holes and tightened bolts. AISC recognized that these procedures might be overly conservative for connections with snug-tight bolts and short slotted holes, and so sponsored this study. The reader interested in the experimental work which led to the standard hole connection design is referred to the paper by Astaneh-Asl, Call and McMullin (1989).

4.3 Rotational Stiffness Behavior

The test connections consisted of a single plate welded to a short column and bolted to a short beam. The beam was loaded with two actuators, one controlling shear and one controlling rotation. The assemblages were loaded along a shear-rotation path. Each actuator was instrumented with a load cell and a Tempesonic displacement transducer. The moment at the weld line and the bolt line could be calculated as:

$$M_w = F_r \times l_{dw} + F_v \times l_{vw}$$

$$M_b = F_r \times l_{rb} + F_v \times l_{vb}$$

where M_w = weld line moment

M_b = bolt line moment

F_r = rotation actuator load

F_v = shear actuator load

l_{rw} = distance from rotation actuator to weld line

l_{rb} = distance from rotation actuator to bolt line

l_{vw} = distance from shear actuator to weld line

l_{vb} = distance from shear actuator to bolt line

Rotation was calculated as:

$$\theta = (d_r - d_v) / l_{dv}$$

where d_r = displacement of rotation actuator

d_v = displacement of shear actuator

l_{dv} = distance between actuators

Moment-rotation curves are shown in Figures 4-1 through 4-4, one for each test specimen. From the moment-rotation data, one can calculate rotational stiffness in a number of ways. A nor-

malized tangent rotational stiffness can be calculated as follows:

$$k_{\theta i} = ((M_i/M^*) - (M_{i-1}/M^*)) / (\theta_i - \theta_{i-1})$$

where k_{θ} = normalized rotational stiffness, (1/radians)

M = moment, at bolt line or weld line

M^* = shear tab plastic moment capacity

$$= d^2 \times t \times F_y/4$$

t = plate thickness

d = plate depth

θ = rotation, radians

i = load step index

Rotational stiffness behavior for each specimen is presented in Figures 4-5 through 4-8. Note that the rotational stiffness for a load step is shown at the high- θ end of the load step, for arithmetic simplicity.

It is clear that the moment-rotation behavior is highly nonlinear, even at low rotations. The three-bolt specimen and the five-bolt specimen have clear stiffness "spikes," possibly associated with points where a bolt begins to bite into the bottom or end of its slot. The seven-bolt and nine-bolt specimens exhibit more complicated behavior, perhaps because of their greater indeterminacy. In general though, at service loads, all four specimens exhibit normalized rotational stiffness between zero and 40 rad^{-1} , where the normalization is as described above.

4.4 Point of Inflection

Knowledge of the point of inflection has many uses in design. The point of inflection is an ideal place to splice a continuous beam. And if a connection exhibits predictable control over the point of inflection, then analysis of the connection is greatly simplified. The moment acting on the elements within the connection can be assessed without reference to the rest of the structure.

Consider a beam uniformly loaded and supported by completely rigid connections. While the beam remains elastic, it has inflection points at $0.21L$ from each end. Once the beam cross sections at the supports begin to yield, the points of inflection move toward the supports. As the load increases, the midspan cross sections begin to yield, until the supports and the midspan have all reached their plastic moment capacity and a collapse mechanism is formed. At this point, the points of inflection are located at $0.146L$ from each end.

However, if the beam supports are semi-rigid or flexible, with nonlinear moment-rotation characteristics, the points of inflection begin to move immediately after loading starts, even though the beam itself might remain elastic.

As shown in the previous section, the shear tab does exhibit flexible, nonlinear moment-rotation characteristics. But knowing the shear, V , on the connection and the moment at the weld line, M_w , one can calculate the eccentricity, or location of the inflection point as $e_w = M_w/V$, where e_w is measured from the weld

line.

The location of the inflection point in this connection can be used to calculate bending moment acting on elements in the connection, such as the bolt group or the weld. Figures 4-9 through 4-12 plot the location of the inflection point as measured from the weld line. The curves indicate that at low shear, the inflection point starts out as far as 40 inches from the weld line. As shear increases, the inflection point moves to a stationary position. For the three-bolt, five-bolt, seven-bolt and nine-bolt specimens, respectively, that stationary point is at 3 inches, 3 inches, 4.5 inches, and 6 inches from the weld line. An empirical relation that describes this behavior is:

$$e_w \geq 2n/3 \text{ inch}$$

also,

$$e_w \geq a \text{ inch}$$

where n = number of bolts

a = distance from bolt line to weld line normally
equal to 3 inches.

The 3 inch distance from the weld line to the point of eccentricity was selected as typical distance from bolt line to weld line. Deviations up 3.5 inch or down to 2.5 inch can be tolerated. However, for larger deviations, appropriate study should be conducted before applying these rules.

01597
76510

4.5 Strength

Five limit states are associated with the single plate shear connection with short slotted holes:

1. Shear yielding of gross section of plate
2. Bolt shear failure
3. Beam web or plate bearing failure
4. Plate net section fracture
5. Weld fracture

The connections studied in this project all failed due to shear fracture of bolts at the following shear loads:

- 3-bolt connection: 92.1 kip
- 5-bolt connection: 151.9 kip *15 7/8 in*
- 7-bolt connection: 189.1 kip
- 9-bolt connection: 250.8 kip

4.5.1 Shear Yielding of Gross Section of Plate

The procedure for design of single plate shear connections that appears in the 9th Edition AISC-ASD Manual provides for shear yielding of the gross area (limit state 1) before the other limit states are reached. Shear yielding of plate gross section was observed to be a gradual process. Yielding was observed to begin in the bottom two-thirds of the plate, at loads between 0.8 and 0.9 R_y . Each specimen was observed to have had its gross section completely yielded in shear by the point when shear reached between 90% and 95% of R_y . To a limited degree in these tests, the bolt holes did yield in bearing before the gross section of the plate had fully yielded. Still, in each test, the gross

section had fully yielded in shear (limit state 1) before any bolts began to tear through the plate in bearing failure (limit state 3).

Shear yielding of the gross section developed gradually in each test, but was adequately predicted as:

$$R_y = 0.577 \times t \times L \times F_y$$

R_y = plate gross area shear yield capacity

t = plate thickness

L = plate length

F_y = yield stress of plate material

The yield stress used in these tests was coupon test yield stress (43.6 ksi), rather than specified material yield stress (36 ksi). Yielding was associated with flaking of the whitewash with which the connection was coated. As loading progressed, patterns associated with shear yielding appeared in the plate between the weld line and the bolt line, as discussed in Chapter 3. Yielding developed from the middle to lower third of the plate, with the top third yielding last. The shear yield patterns and the observation that the plate area at the top of the plate seemed to yield last, indicates that shear effects dominated plate stresses, rather than beam-type moment effects. That plates had yielded fully by the time shear had reached 95% of R_y suggests that moment effects may have reduced shear strength. The calculated R_y for each specimen follows:

3-bolt connection: 77.8 kip

5-bolt connection: 134.4 kip

66516
7-bolt connection: 191.0 kip

9-bolt connection: 247.6 kip

Step 1 of the Single Plate Shear Connection design procedure in the 9th Edition of the ASD Manual requires that the designer calculate allowable plate shear capacity in yielding, R_o , in kips, as given by:

$$R_o = 0.4 (36 \text{ ksi}) \times L \times t$$

Thus the implicit factor of safety is $0.577 / 0.4 = 1.44$.

Rounding 0.577 to 0.6, the factor of safety is about 1.5.

Note that $L = 3" \times n$, so

$$\begin{aligned} R_o &= 0.4 \times 36 \text{ ksi} \times 3" \times n \times t \\ &= 43.2 \text{ k/in} \times n \times t \end{aligned}$$

As Astaneh, Call, and McMullin (1988) pointed out, and as will be shown later, gross section plate yielding never governs allowable stress design of shear tabs, and thus the nominal factor of safety is greater than 1.5.

It would be consistent with the LRFD Specification (AISC 1986) to require that, in a load and resistance factor design of the shear tab with either standard or short slotted holes, the gross section yield capacity ϕR_o , kips be:

In Load and Resistance Factor Design Method , LRFD

$$\phi R_o^* = \phi \times 0.6 \times F_y \times A_g$$

where

$$\phi = 0.90$$

$$A_g = L \times t = 3" \times n \times t$$

n = number of bolts

R_o^* = Nominal shear yield capacity

and hence,

$$\begin{aligned}\phi R_o^* &= 0.90 \times 0.6 \times (36 \text{ ksi}) \times 3" \times n \times t \\ &= 58.3 \text{ k/in} \times n \times t\end{aligned}$$

4.5.2 Bolt Shear Failure

In each test, failure occurred when the bolts simultaneously fractured in shear (limit state 2), but this occurred after limit state 1 was reached and the plate gross area had fully yielded. The bolts were 3/4 in. A490-N, which according to the AISC-LRFD Manual, in Table 1-D, have specified ultimate strength in shear of 19.4 kip per bolt.

To evaluate true bolt shear strength, one must first divide fracture load by the coefficient C for eccentric loads on fastener groups. The 9th Edition AISC-ASD Manual Table XI provides coefficients C for eccentric loads on fastener groups.

Taking

$$l = e_w - 3 \text{ in.}$$

where

e_w = the larger of 3 in. or $n \times 2/3$ in.,

C can be read as follows:

3-bolt connection: C = 3

5-bolt connection: C = 4.90

7-bolt connection: $C = 6.57$

9-bolt connection: $C = 8.17$

Dividing bolt shear fracture load by C , one can estimate mean bolt strength r_v as follows:

3-bolt connection: $r_v = 92.1 \text{ kip} / 3.00 = 30.7 \text{ kip}$

5-bolt connection: $r_v = 151.9 \text{ kip} / 4.90 = 31.0 \text{ kip}$

7-bolt connection: $r_v = 189.1 \text{ kip} / 6.57 = 28.8 \text{ kip}$

9-bolt connection: $r_v = 250.8 \text{ kip} / 8.17 = 30.7 \text{ kip}$

The mean value of r_v as calculated above is 30.3 kip. The standard deviation is 1.01 kip. The small standard deviation tends to verify the estimate for bolt line eccentricity.

The ratios of connection failure load (limit state 2) to plate gross area shear yield capacity (limit state 1) were:

3-bolt specimen: $92.1 \text{ kip} / 77.8 \text{ kip} = 1.18$

5-bolt specimen: $151.9 \text{ kip} / 134.4 \text{ kip} = 1.13$

7-bolt specimen: $189.1 \text{ kip} / 191.0 \text{ kip} = 0.99$

9-bolt specimen: $250.8 \text{ kip} / 247.6 \text{ kip} = 1.01$

These ratios indicate the degree of assurance that limit state 1 will be reached before limit state 2; that the connection will experience ductile failure through shear yielding, rather than sudden failure through bolt shear. Note that the shear yield capacities used above are based on the coupon test yield strength, 43.6 ksi. Using the material specified yield strength

of 36 ksi, these ratios increase by 21% (43.6/36.0 = 1.21), but the ratios would suggest greater assurance of ductile failure than actually existed.

Note that the ratio decreases with increasing connection depth, because of the increasing moment effects on bolt strength.

4.5.3 Bearing Failure of Bolt Holes

The standard hole shear tab design procedure in the AISC-ASD 9th Edition Manual requires that the designer check plate bearing allowable strength P_b by:

$$P_b \leq 1.2 F_u \times t \times d_b$$

For the plates used in this study, $F_u = 58$ ksi, $t = 0.375$ ", and $d_b = 0.75$ in. This leads to:

$$P_b \leq 1.2 \times 58 \text{ ksi} \times 0.375" \times 0.75" = 19.6 \text{ kip per bolt.}$$

Since the specified shear capacity r_v of the 3/4" A490 bolt is 19.4 kip, this requirement was satisfied for these specimens. Using A325 bolts, which have lower shear capacity, would also lead to adequate plate bearing capacity. The design assumptions in the standard hole shear tab design procedure hold that

$$F_y = 36 \text{ ksi}$$

$$t \leq d_b/2 + 1/16"$$

$$\text{so, } P_b \leq 1.2 \times 58 \text{ ksi} \times (d_b/2 + 1/16") \times d_b$$

$$P_b \leq 69.6 \text{ ksi} \times d_b^2 + 4.35 \text{ k/in} \times d_b$$

P_b must be at most r_v , and since

$$r_v = 0.577 F_{ub} \times 3.1416 \times d_b^2 / 4$$

this reduces to:

10916

$d_b \geq -0.07"$ for A325 bolts and

$d_b \geq -0.08"$ for A490 bolts

which indicates requirements are always satisfied.

In each test, bolt holes exhibited substantial local yielding before the plate gross area had completely yielded. None exhibited bolt hole bearing failure. By ultimate, however, the 9-bolt specimen had developed a 5/16 in. fracture at the bottom of the plate beneath the bottom hole, suggesting imminent bearing failure of the bottom bolt hole.

Yielding or fracture of the plate region beneath the bottom bolt hole raises two concerns: first, that the bottom bolt is not being used to its greatest efficiency, because bolt hole capacity may govern the load that the bolt transfers rather than the bolt capacity; second, that fracture of the plate material beneath the bottom bolt hole may initiate an unzipping effect as the load on the bottom bolt is suddenly released and transferred to the remaining bolts. The load on these bolts would suddenly increase, likely beyond their strength. Thus the capacity of the plate beneath the bottom bolt could govern the connection capacity.

In shear tabs with short slotted holes the bottom bolt hole shear capacity is more of an issue than in the standard hole connection; the material beneath the bottom short slotted hole begins to look like a short beam spanning between the ends of the hole. It is therefore important to ensure that adequate edge distance is provided beneath this hole. The design procedure in the AISC-ASD 9th Edition Manual requires that minimum vertical

edge distance be 1.5". Because of an oversight, the edge distance provided in these specimens was only $1.5 d_p$, or 1.125". For the most part these samples performed well, though bulging of the plate beneath the bottom hole was observed, suggesting that the shear transferred by the bottom bolt might have been reduced because of plate bearing yielding. The 1.5" minimum vertical edge distance requirement should reduce this effect, and is strongly recommended to be observed.

4.5.4 Plate Net Section Fracture

Step 4 of the design procedure for the standard hole shear tab in the 9th Edition ASD manual requires that the designer check allowable capacity of net section of plate in shear fracture, R_{NS} , kips as:

$$R_{NS} = 0.3 (58 \text{ ksi}) [L - n (d_p + 1/16")] t$$

If R_{NS} is made at least to be equal to T_o , then the shear yielding of plate will govern. For this to happen, minimum value of d_p can be calculated as:

$$R_{NS} = 0.3 (58 \text{ ksi}) [3" \times n - n (d_p + 1/16")] t$$

which should be equal to R_o , then:

$$R_{NS} = 43.2 \text{ k/in} \times n \times t$$

This results in d_p being less than 0.455 inch. In other words whenever $d_p > 0.455"$, net section fracture capacity R_{NS} governs the allowable shear capacity of shear tabs with standard holes. The ratio of allowable gross area yield shear capacity to net section allowable shear fracture capacity for a connection

using 3/4" bolts would be:

$$\begin{aligned} R_o / R_{ns} &= [(43.2 \text{ k/in}) n t] / [(38.1 \text{ k/in}) n t] \\ &= 1.13 \end{aligned}$$

which would indicate the ASD factor of safety favoring net section fracture over gross section yield for plate shear capacity.

It would be consistent with the Load and Resistance Factor Design Manual to specify the LRFD net section shear fracture capacity ϕR_{ns} as

$$\begin{aligned} \phi R_{ns}^* &= \phi \times 0.6 \times F_u \times A_{ns} \\ &= 0.75 \times 0.6 \times 58 \text{ ksi} \times [L - n \times (d_b + 1/16")] \times t \end{aligned}$$

When compared with gross section shear yield capacity ϕR_o^* , and taking $L = 3" \times n$, it turns out that for $d_b < 1.075"$, gross section shear yield always governs plate shear capacity. Recall that in the ASD method, net section shear fracture always governs plate shear capacity. For $d_b = 3/4"$, the ratio of net section shear fracture capacity to gross section shear yield capacity is:

$$(\phi R_{ns}^*) / (\phi R_o^*) = 57.1 / 48.6 = 1.17$$

Which gives some indication of the typical LRFD factor of safety favoring gross section yield over net section fracture for plate shear capacity, almost exactly the same as the ASD factor favoring the opposite plate shear mechanism. This points out a common inconsistency between the ASD and LRFD methods which results from ASD's more subjectively chosen factors of safety.

4.5.5 Weld Fracture

Step 2 in the current allowable stress design procedure for standard hole shear tabs requires that the designer calculate fillet weld size, D in sixteenths, to develop R_o ,

$$D = R_o / (L \times C)$$

where C is taken from AISC-ASD-9th Ed. Manual, Table XIX, assuming $a_1 = 3"$ or $n \times 1"$, whichever is larger.

This would be overly conservative for the short slotted hole shear tab, because the eccentricity of the load from the weld line, a_1 (called e_w elsewhere in this report) is less for the shear tab with short slotted holes and snug-tight bolts. As indicated above in Section 4.4 Point of Inflection, a_1 can be taken as $3"$ or $n \times 2/3"$, whichever is larger.

In order to ensure that plate will yield before welds yield, the shear-moment interaction curve of the plate should lie inside the shear-moment interaction curve for the welds. It is suggested that a factor of safety of 1.5 be The M-V interaction curve (yield surface) for rectangular cross sections such as shear tabs can be approximated by a circle given by:

$$(V/V_y)^2 + (M/M_p)^2 = 1.0$$

To establish interaction equation for welds, we can use values given in Table XVIII of the AISC-LRFD Manual¹. The values in the table corresponding to $k=0$ should be considered. Using the table, one can assume an eccentricity and calculate V and M and plot the M-V interaction curves for weld failure. This is done and the results indicate that the interaction curve can be

approximated, conservatively, by a circle.

Therefore, in order to ensure that failure surface for the weld lines is greater than the failure surface for the plate, the following equation should be satisfied:

$$[(V/V_{yw})^2 + (M/M_{pw})^2] > [(V/V_y)^2 + (M/M_p)^2]$$

where;

$$V_{yw} = 2(0.5F_{Exx})(0.707D)(L)$$

$$M_{pw} = 2(0.5F_{Exx})(0.707D)(L^2/4)$$

$$V_y = (F_y)(t)(L)$$

$$M_p = (F_y)(t)(L^2/4)$$

$$M = V(e_w)$$

In the above equations a value of $0.5F_{Exx}$ is used as the yield strength of the welds.

By combining the above equations, the value of D/t ratio is calculated as:

$$D/t > 1.41F_y/F_{Exx}$$

Satisfying the above equation will ensure that failure surface, i.e. interaction curve, for the weld is at least 1.5 times greater than that of the plates. Using F_y and F_{Exx} equal to 36 ksi and 70 ksi respectively:

$$D/t > 0.75$$

The above derivations were done for single plate shear connections with standard holes. Based of performance of test specimens the authors feel that the welds in single plte shear connections with standard or short slotted holes are subjected to similar forces and behave in similar manner, thus should be

designed the same way for both types of connections.

In treating single plates with standard holes, the derivations similar to above procedure was done and exactly the same equation as the above equation was obtained. The equation indicates that in single plate shear connections with standard or short slotted holes, two weld lines with a weld size equal to $0.75t$ one on each side of the plate are necessary to ensure plate failure before weld failure. If this rule is satisfied, the design will result in a "matching " weld where plate yielding will occur before widespread yielding of the weld.

The four specimens tested in this research used the $0.75t$ "matching weld size" rule, and experienced no distress. In the 3-bolt, 5-bolt, and 7-bolt tests, the heat affected zone, the region on the plate within about $1/2$ in. of the weld line, displayed no signs of yield before the connection failed.

After completion of the test of the 9-bolt specimen, a 2" to 2- $1/2$ " long fracture was observed emerging at the top of the plate, and running along the weld line. It had not been noticed before, and no evidence on the videotape or photographs would indicate that it was present before collapse. It may have occurred as a result of the beam top flange impacting on the plate top edge after the bolts sheared off. However, the absence of shear yield patterns in the whitewash along the top about 1" of plate suggests that the fracture may have developed during loading as the shear yield patterns along the rest of the plate developed. This could indicate two things: first, that shear and

beam-type moment effects during loading combined to cause the brittle, heat-affected zone at the top fiber to fracture in tension and shear, or second, that the fracture had been present before the test began, perhaps from thermal stresses resulting from welding. In either case, the presence of this fracture might seem to be adequate cause to recommend that the 9-bolt connection not be used until further tests verify its adequacy. Since this study was performed, researchers at the University of California, Berkeley, performed a test of a single plate shear connection with nine tightened bolts in standard holes, and observed no weld line fractures.

As has been noted earlier, the single plate shear connection with tightened bolts in standard holes experiences greater moment than the connection with snug-tight bolts in short slotted holes, and thus is more of a limiting case. Since this later experiment did not experience any fracture at the weld line, it seems safe to conclude that the fracture in the present study most likely occurred after collapse, as a result of impact. Hence, it is recommended that limit on the number of bolts in the single plate shear connection with snug-tight bolts in short slotted holes be increased to a maximum of 9 bolts.

4.5.6 Design Tables for Shear Tabs with Short Slotted Holes

The ASD design tables for shear tabs with short slotted holes are presented in Appendix C. They include shear tabs with 2 to 9 bolts, with A325 and A490 high strength bolts, with d_b between 3/4" and 1", and plate thickness from 1/4" to 9/16".

Only connections where plate thickness $t \leq d_b/2 + 1/16$ " are presented.

Where this condition is not met, the phrase " $t > d_b + 1/16$ Governed" appears in the tables. Welds should be designed following $w \geq 3/4 t$ rule. In the Tables;

- N = number of bolts
- t = plate thickness, inches
- db= diameter of bolts.

4.6 Bolt Group Efficiencies

As discussed earlier, use of short slotted holes instead of round holes results in smaller eccentricities of shear from the bolt line in the shear tab connections. The smaller eccentricity, in turn, results in smaller moments in the connections with slotted holes thus the connection bolts can carry larger shear in connections with slotted holes. Figure 4-13 shows eccentricities of shear force from the bolt line for connections with slotted as well as standard holes. The design equations proposed in this report to calculate eccentricities are also plotted in the figure. As figure indicates, the eccentricities for connections with slotted holes are much smaller than those for standard round holes.

CHAPTER 5

PROPOSED DESIGN PROCEDURES REFINEMENTS

5.1 General

These design procedures are intended for single plate framing connections with short slotted holes in the single plate and snug-tight bolts. Between two and nine bolts may be used. The single plate framing connection must satisfy the material and geometric requirements stated in the 9th Edition of the AISC-ASD Manual.

The procedures which follow are based on the research discussed in the previous chapters. Astaneh (1987) studied the shear and rotation effects at the ends of flexibly-supported beams and developed a shear-rotation relationship which would impose realistic strength and ductility demands on a flexible support. Astaneh, Call and McMullin (1989) used a special test set-up and applied this load line to single plate framing connections with standard holes and tightened bolts. They subsequently produced the design procedures which now appear in the 9th Edition AISC-ASD Manual. During the course of the present research, similar procedures were used to study single plate framing connections with short slotted holes and snug-tight bolts.

This research determined that the connection provided more rotational flexibility than the single plate framing connections with standard holes and tightened bolts. Otherwise, general behavior and limit states were unchanged. The present research also indicated that this connection could accommodate up to nine bolts.

5.2 Proposed Allowable Stress Design Procedure Refinements

The following modifications are proposed for single plate framing connections which use snug-tight bolts and short slotted holes in the single plate. They make reference to nomenclature which appears in the Single Plate Shear Connections section of the 9th Edition AISC-ASD Manual.

1. In calculating fillet weld size, C may be taken from Table XIX, assuming $a_1 = 3 \text{ in.}$ or $n \times 2/3"$, whichever is larger, and $k = 0$.
2. In calculating bolt group capacity, C may be taken from Table XI assuming $l = 2 \text{ in.}$ or $(n \times 2/3" - 3")$, whichever is larger.
3. Up to 9 bolts may be used.

5.3 Application to Design Problems

The following example illustrates application of the design procedure using the proposed modifications.

Given:

Beam: W27 x 144, $t_w = 0.570$ in., A36 steel

Reaction: 95 kips (service load)

Bolts: 7/8 in., A490-N, snug-tight, with 3-in. spacing

Holes: Plate: short slotted; Beam: standard round

Welds: E70XX fillet welds

Solution:

1. Calculate number of bolts:

$$R = 90 \text{ kip}$$

Assume $M = 0$

$$n = R / r_v = 90 \text{ kip} / 16.8 \text{ kip} = 5.35$$

Try 6 bolts.

Check moment at bolt line: Using Table XI,

$$l = \text{greater of } 2" \text{ or } (n \times 2/3" - 3")$$

$$l = \text{greater of } 2" \text{ or } (6 \times 2/3" - 3") = 1"$$

$$l = 2"$$

$$C = 5.45$$

$$P = C \times r_v = 5.45 \times 16.8 \text{ kip} = 91.56 \text{ kip O.K.}$$

USE 6 BOLTS

2. Calculate plate thickness required for net section shear fracture (always governs over gross section shear fracture)

$$R_{ns} = 0.3 \times 58 \text{ ksi} \times [L - n(d_b + 1/16 \text{ in.})] \times t$$

$$L = 3 \text{ in.} \times n = 18 \text{ in.}$$

$$t_{reqd} = 90 \text{ kip} / (0.3 \times 58 \text{ ksi} \times [18 - 6(7/8 + 1/16)] \text{ in.})$$

$$t_{reqd} = 0.417 \text{ in.}$$

TRY 1/2 in. PLATE

3. Check plate thickness limit

$$t \leq d_b/2 + 1/16 \text{ in.}$$

$$t \leq 7/8 \text{ in} / 2 + 1/16 \text{ in.}$$

$$t \leq 1/2 \text{ in. O.K.}$$

USE 1/2 in. PLATE

4. Check gross section allowable shear yield capacity

$$R_o = 0.4 \times 36 \text{ ksi} \times L \times t$$

$$R_o = 0.4 \times 36 \text{ ksi} \times 18 \text{ in.} \times 1/2 \text{ in.}$$

$$R_o = 129.6 \text{ kip O.K.}$$

5. Calculate fillet weld size, D in sixteenths, to develop R_o

$$D = R_o / (L \times C)$$

C is taken from Table XIX, where a_1 is the greater of 3 in.

or $n \times 2/3$ in. ($= 6 \times 2/3$ in. = 4 in.)

$$a_1 = 4 \text{ in.}$$

$$l = L = 18 \text{ in.}$$

$$a = 4 / 18 = 0.222$$

$$k = 0$$

$$C = 1.33 \text{ (interpolated)}$$

$$D = 129.6 / (18 \times 1.33)$$

$$D = 5.4$$

USE 3/8 in. FILLET WELD

Notice that using $w=0.75t$ rule would result in exactly the same weld size:

$$w=0.75t=0.75 \times 0.5=0.375"$$

6. Check plate bearing capacity, P_b

$$R_b = C_{\text{bolt}} \times 1.2 \times F_u \times t \times d_b$$

$$R_b = 5.725 \times 1.2 \times 58 \text{ ksi} \times 0.5 \text{ in.} \times 7/8 \text{ in.}$$

$$R_b = 174.3 \text{ kip } \underline{\text{O.K.}}$$

Beam web is thicker than plate, so there is no need to check bearing of beam web.

7. Beam is not coped, so there is no need to check block shear.

CHAPTER 6

CONCLUSIONS

6.1 General

The main objectives of this study were threefold: first, to determine the effects of using snug-tight bolts and short slotted holes in single plate framing connections, including any increase in rotational flexibility, and any change in general behavior or limit states; second, to develop appropriate modifications to the existing allowable stress design procedure for this class of connections; and third, to determine if the connection can safely accommodate nine bolts. The specific findings presented in this chapter were presented in earlier chapters. The conclusions presented here reflect tests of single plate framing connections with nine or fewer snug-tight bolts in short slotted holes, connected to beams with standard holes. The connections were designed according to the material and geometrical requirements for the single plate framing connection, presented in the 9th Edition of the AISC-ASD Manual. The conclusions of this study should not be applied to cases which differ significantly from those studied here.

6.2 Conclusions

1. The current AISC-ASD procedure for single plate framing connections bases design of welds and bolts on the effects of shear and moment. The plate is designed for shear only. The moment is expressed as the shear acting at an eccentricity from the weld of the greater of 3" or $n \times 1"$ where n represents the number of bolts in standard holes. It was expected that using snug-tight bolts in short slotted holes might increase connection flexibility and reduce eccentricity. This was found to be the case in these experimental studies. Where snug-tight bolts and short slotted holes were used, eccentricity from the weld line could be approximated as the greater of 3" or $n \times 2/3"$, where n represents the number snug-tight bolts in short slotted holes.
2. As a consequence of the increased connection flexibility the snug-tight bolts and short slotted holes provide, bolt shear efficiency can be increased as much as 18%, and weld shear efficiency can be increased as much as 24% (for seven-bolt connections). These figures indicate that a six-bolt connection with snug-tight bolts and short slotted holes could carry the same load as a seven-bolt connection with tightened bolts in standard holes. Where fewer bolts are used, these benefits decrease.
3. The single plate framing connection with short slotted holes and snug-tight bolts may lack adequate ductility to safely

accommodate connections with nine bolts. The nine-bolt specimen in these tests experienced a short fracture along the plate near the weld line at the top end, possible as a result of inadequate ductility. A complete fracture along the entire weld would result in catastrophic collapse of the connection.

4. General behavior and limit states were unaffected by the use of short slotted holes and snug-tight bolts, rather than tightened bolts in standard holes.

REFERENCES

1. American Institute of Steel Construction, AISC (1989), Manual of Steel Construction; Allowable Stress Design 9th Edition,
2. American Institute of Steel Construction, AISC (1986), Manual of Steel Construction; Load and Resistance Factor Design 1st Edition.
3. Astaneh, A. (1987), "Experimental Investigation of Tee-Framing Connection," Progress Report, submitted to American Institute of Steel Construction, April.
4. Astaneh, A., (1989), "Demand and Supply of Ductility in Steel Shear Connections," Journal of Constructional Steel Research, Vol. 14, No. 1.
5. Astaneh, A., S. Call, and K. McMullin, (1989), "Design of Single Plate Shear Connections," Engineering Journal American Institute of Steel Construction, Vol 26, No. 1.
6. Astaneh, A., and M. Nader, (1989), "Design of Tee Framing Shear Connections," Engineering Journal American Institute of Steel Construction, Vol 26, No. 1.
7. Hormby, D.E., R.M. Richard, and J.D. Kriegh, (1984), "Single Plate Framing Connections with Grade-50 Steel and Composite Construction," Engineering Journal American Institute of Steel Construction, Vol 21, No. 3.
8. Lipson, S.L., (1977), "Single-Angle Welded-Bolted Connections," Journal of the Structural Division Proceedings of the American Society of Civil Engineers, Vol 103, No. ST3, March.
9. McMullin, K. and A. Astaneh, (1988), "Analytical and Experimental Investigations of Double-Angle Connections," Report No. UCB/SEMM-88-14, Department of Civil Engineering, University of California, Berkeley, August.
10. Pillinger, A.H., (1988), "Structural Steelwork: a Flexible Approach to the Design of Joints in Simple Construction," The Structural Engineer, Journal of the Institute of Structural Engineers, Vol 66, No. 19, 4 October.
11. Richard, R.M., P.E. Gillett, J.D. Kriegh, and B.A. Lewis, (1980), "The Analysis and Design of Single Plate Framing Connections," Engineering Journal American Institute of Steel Construction, Vol 17, No. 2.

- 91529
12. White, R.N., (1965), "Framing Connections for Square and Rectangular Structural Tubing," Engineering Journal American Institute of Steel Construction, Vol 2, #3, July 1965

FIGURES

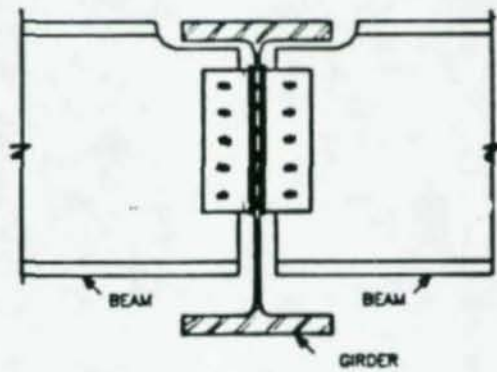
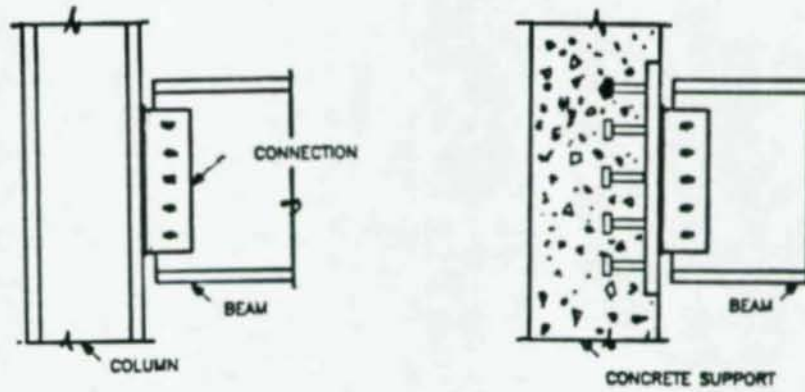

Figure 1-1: Typical applications of single plate shear connections

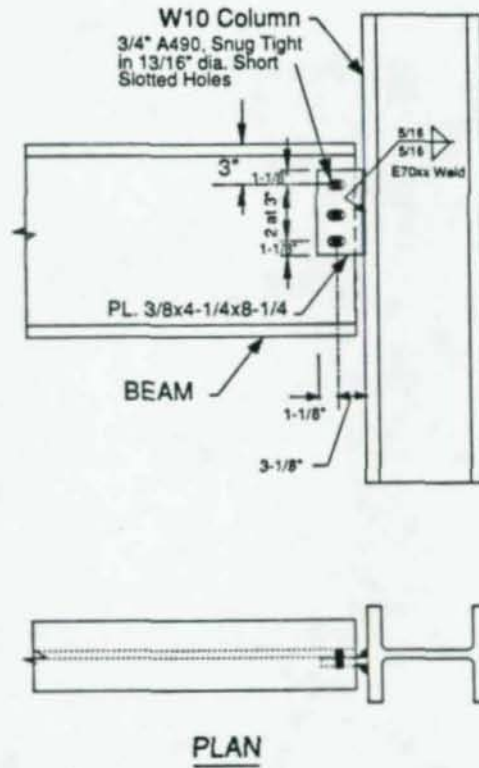

Figure 2-1: Three-bolt test specimen

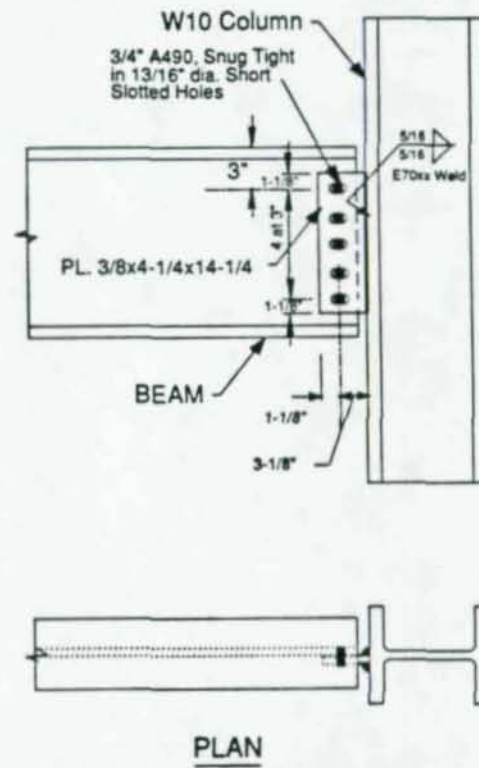
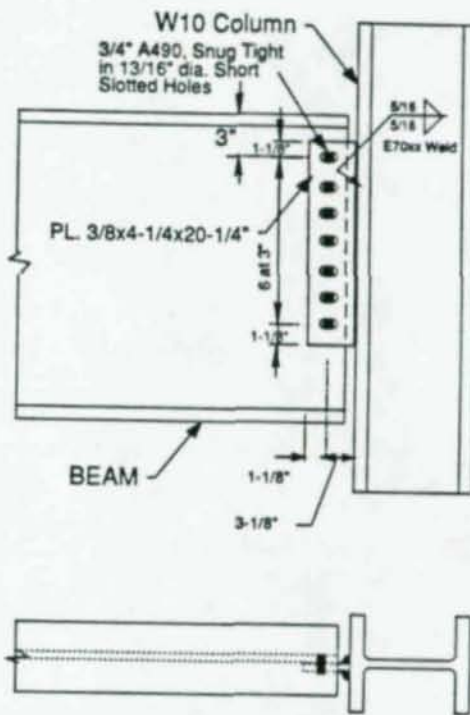
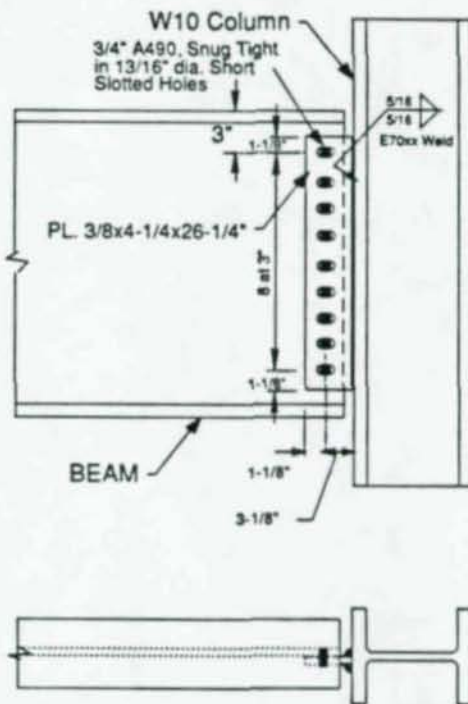

Figure 2-2: Five-bolt test specimen



PLAN

Figure 2-3: Seven-bolt test specimen



PLAN

Figure 2-4: Nine-bolt test specimen

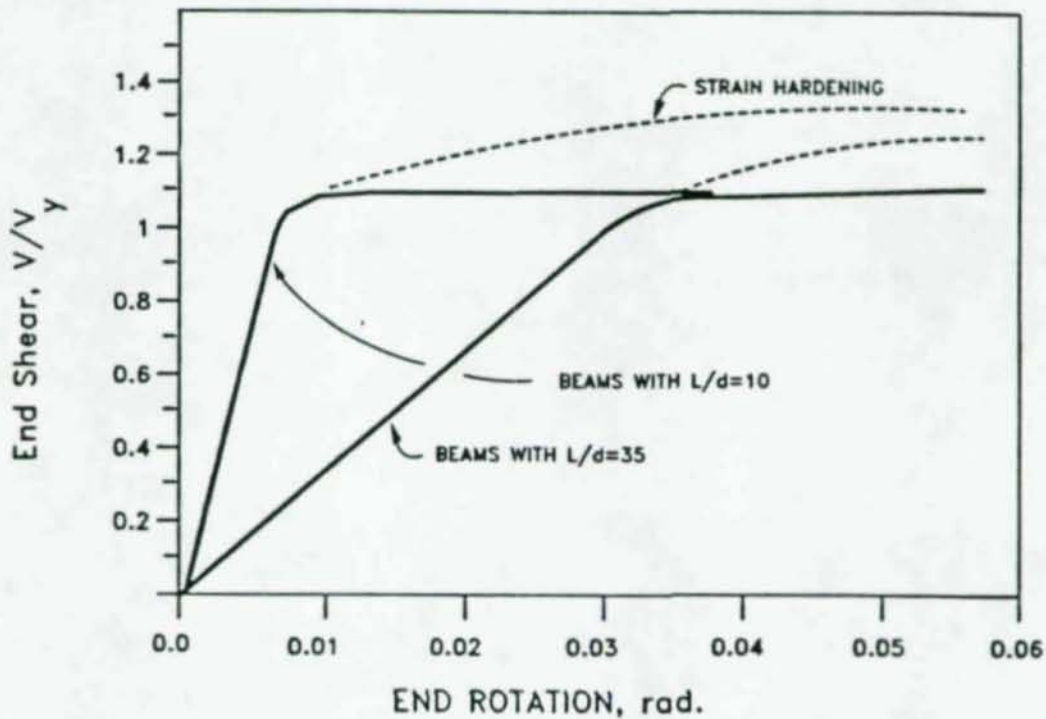

Figure 2-5: Shear-rotation curves of typical beams

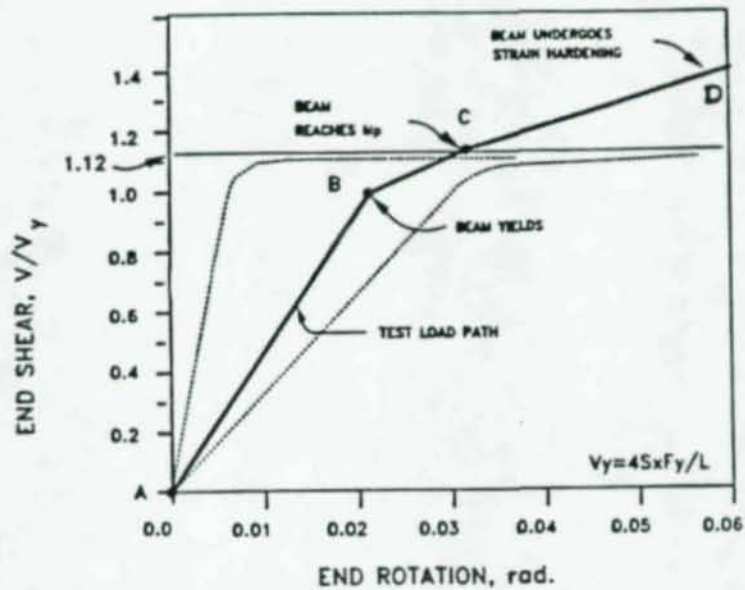

Figure 2-6: Shear-rotation curve used for this project

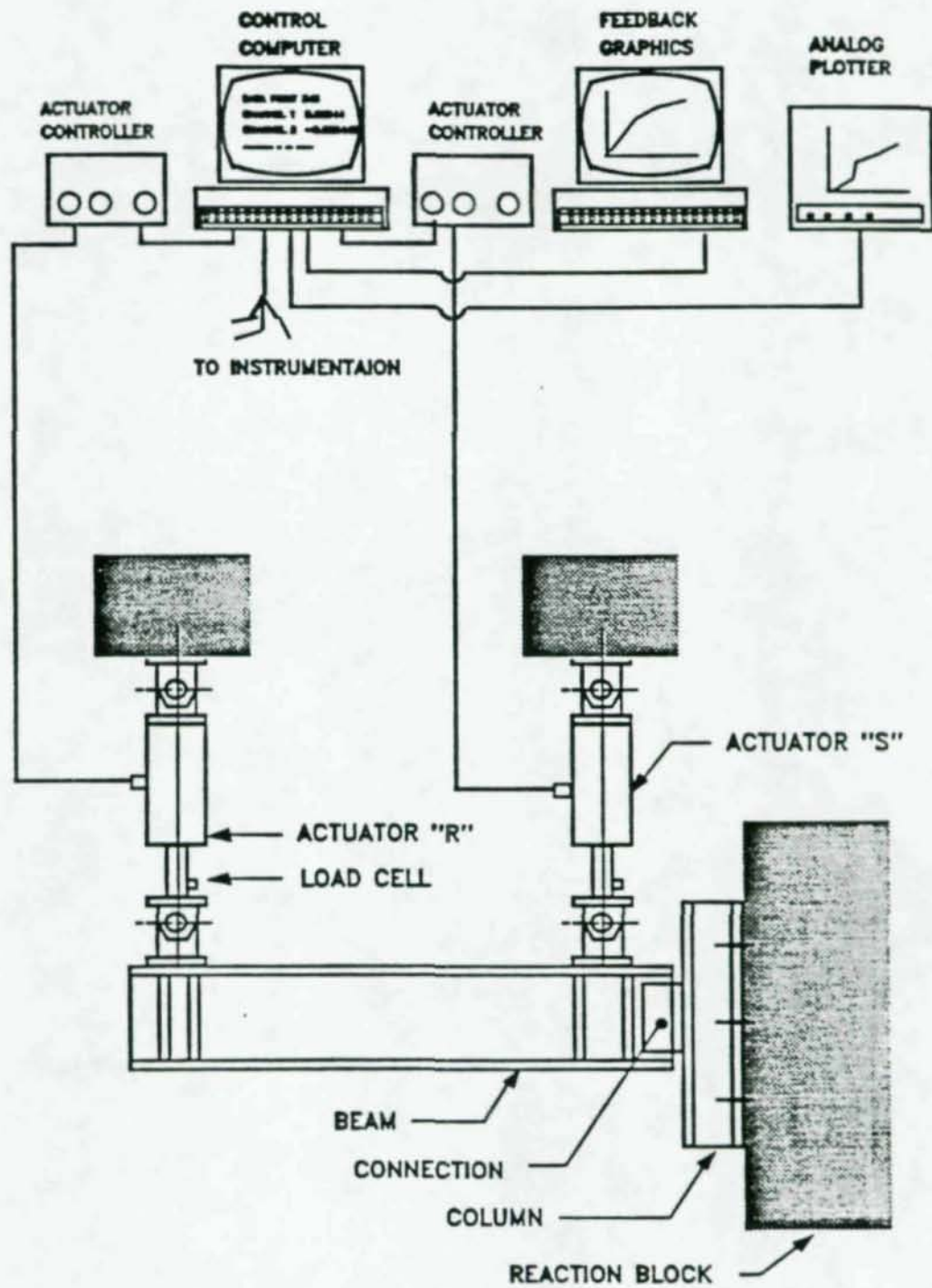

Figure 2-7: Test set-up used in the investigation

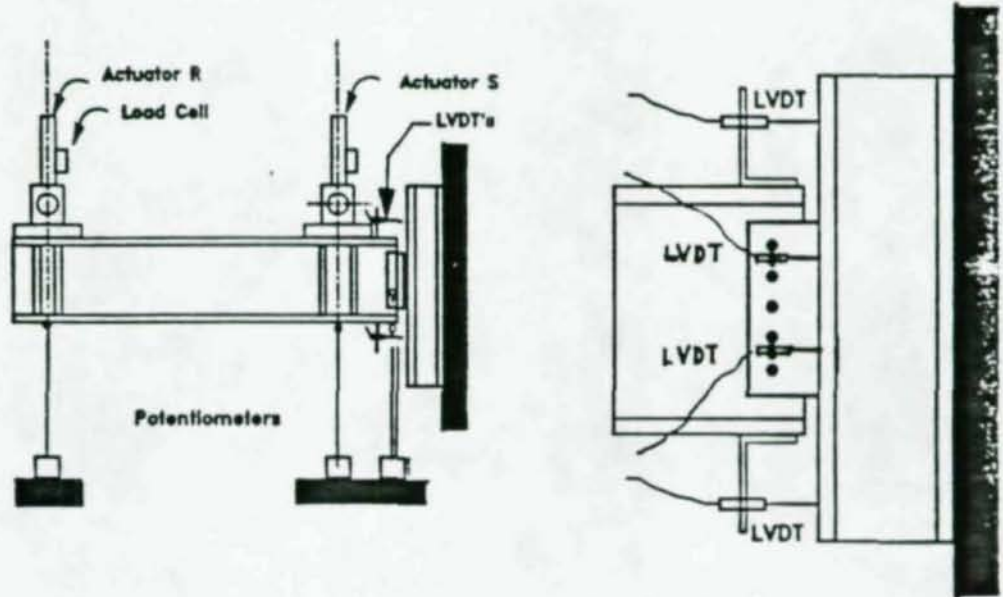

Figure 2-8: Instrumentation

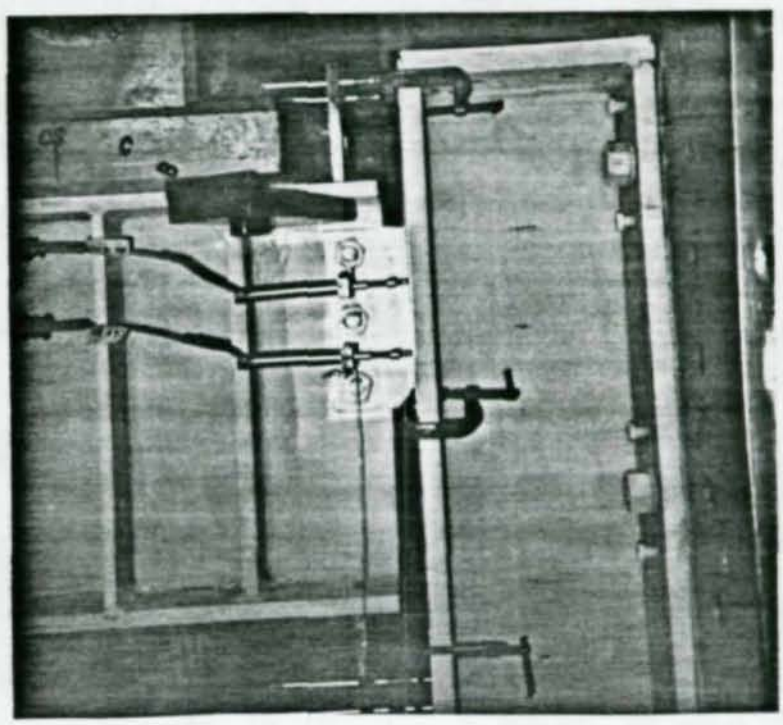

Figure 3-1: A view of three-bolt specimen

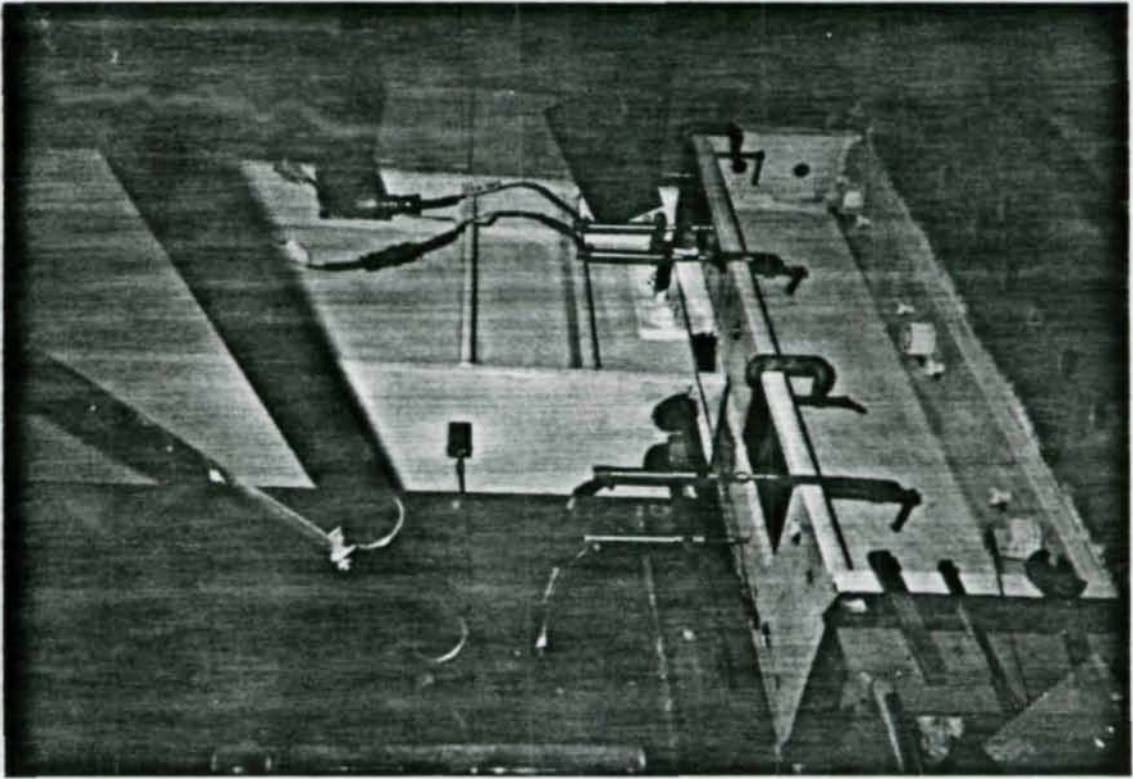

Figure 3-2: A view of three-bolt specimen

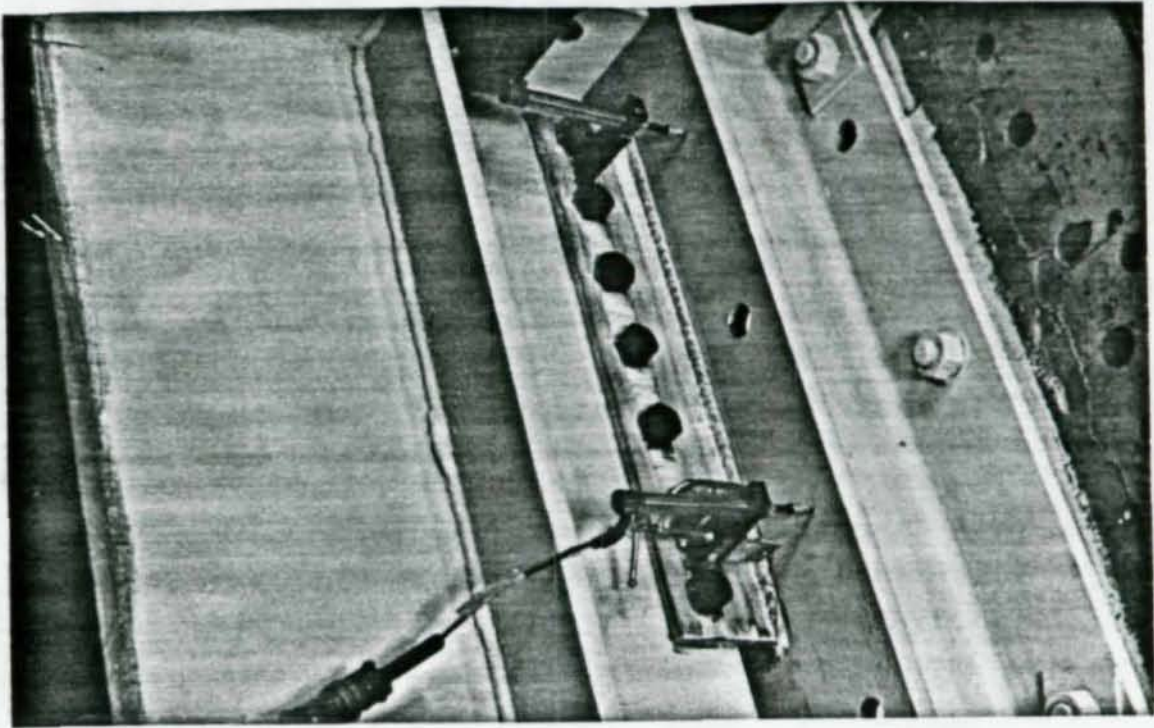

Figure 3-3: A view of seven-bolt specimen

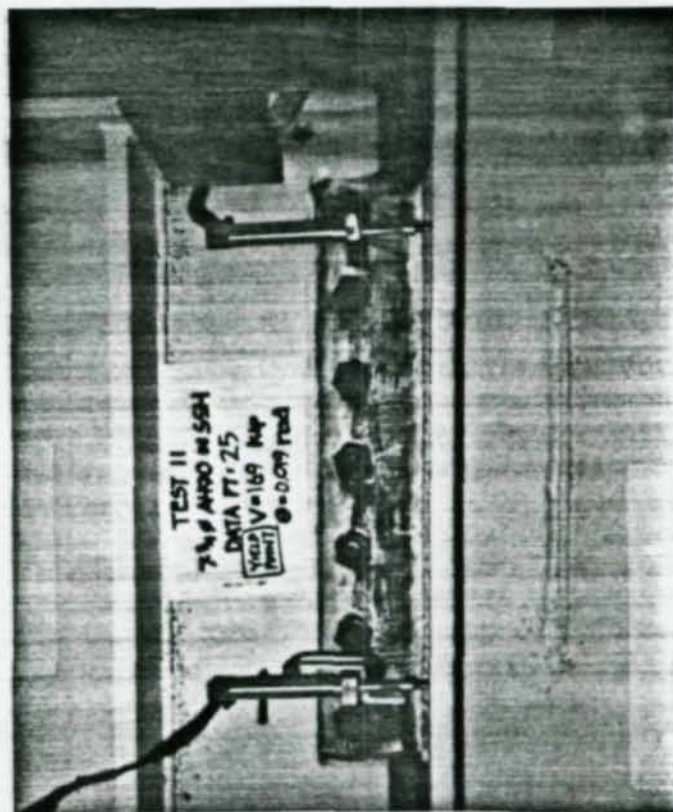

Figure 3-4: Shear yielding of specimen with 7 bolts

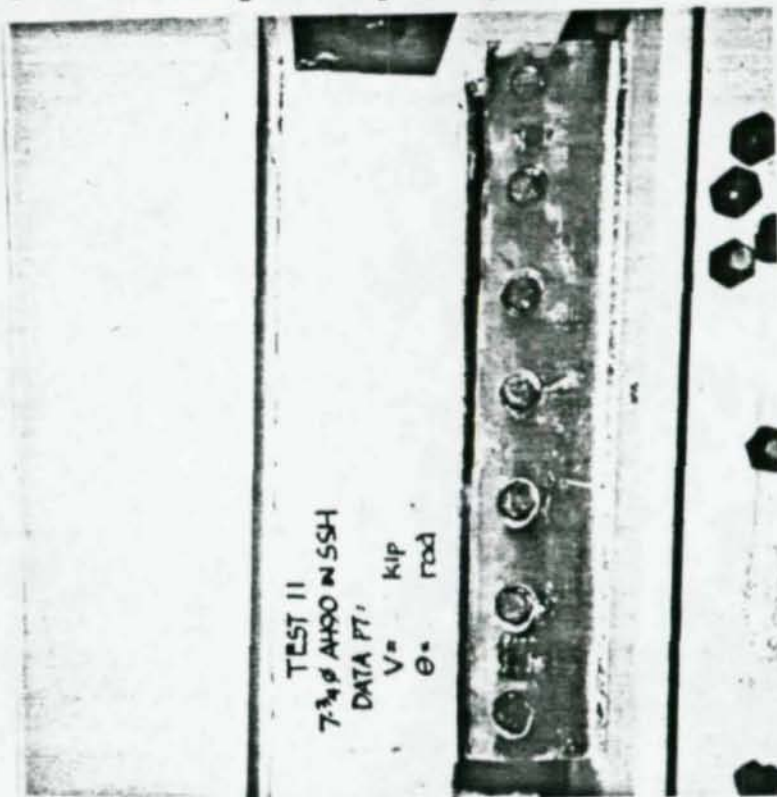
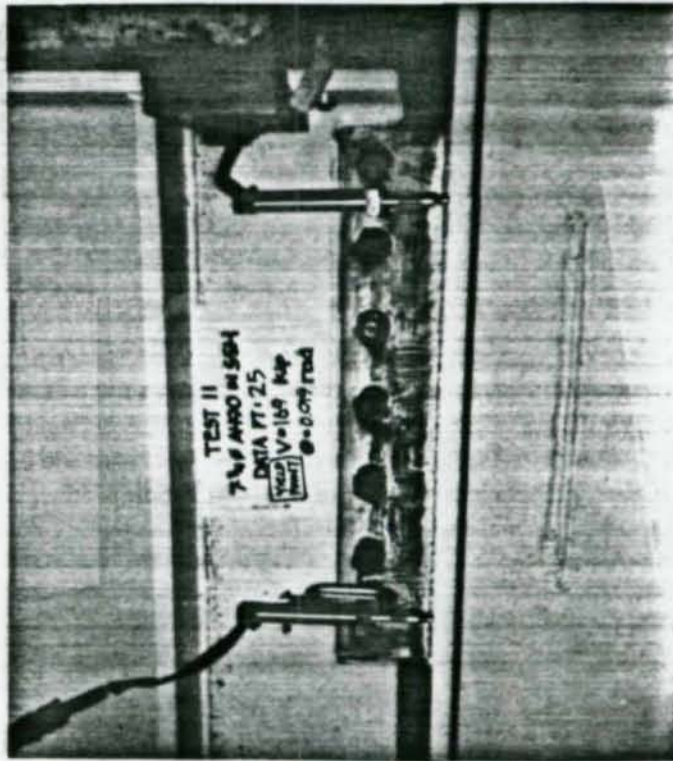
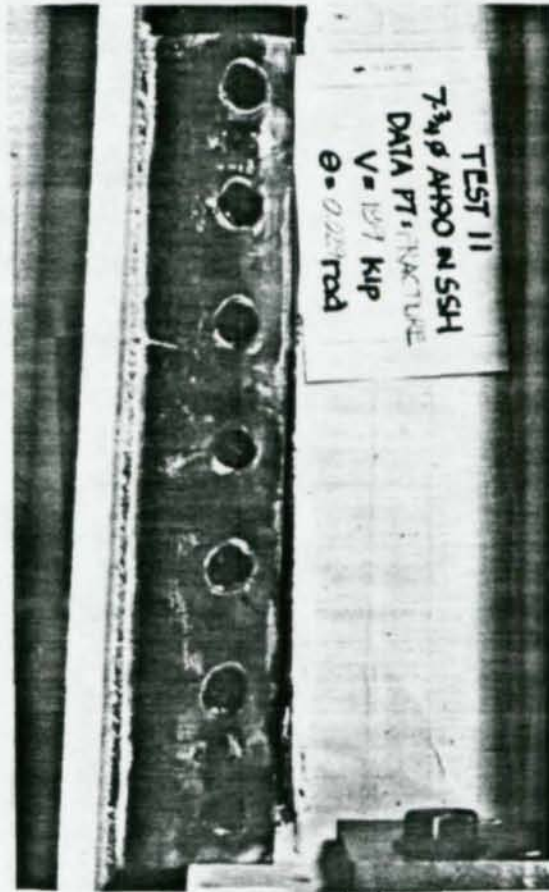

Figure 3-5: Specimen with 7 bolts at the end of test



(a)



(b)

Figure 3-6: Shear Yielding of Specimen with 7 bolts

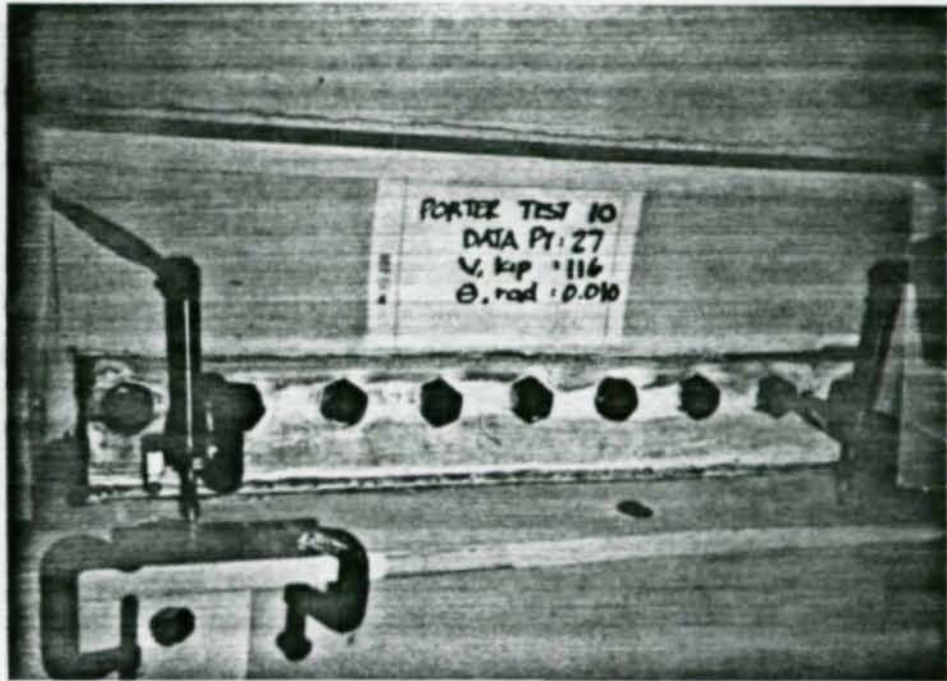

Figure 3-7: Start of shear yielding in 9-bolt specimen

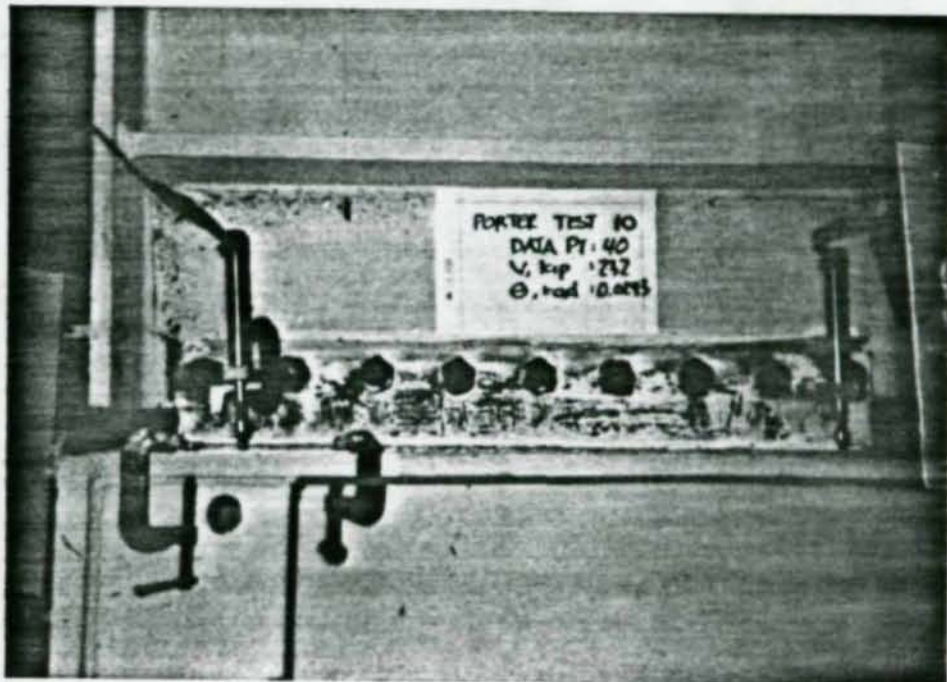

Figure 3-8: Considerable shear yielding of 9-bolt specimen

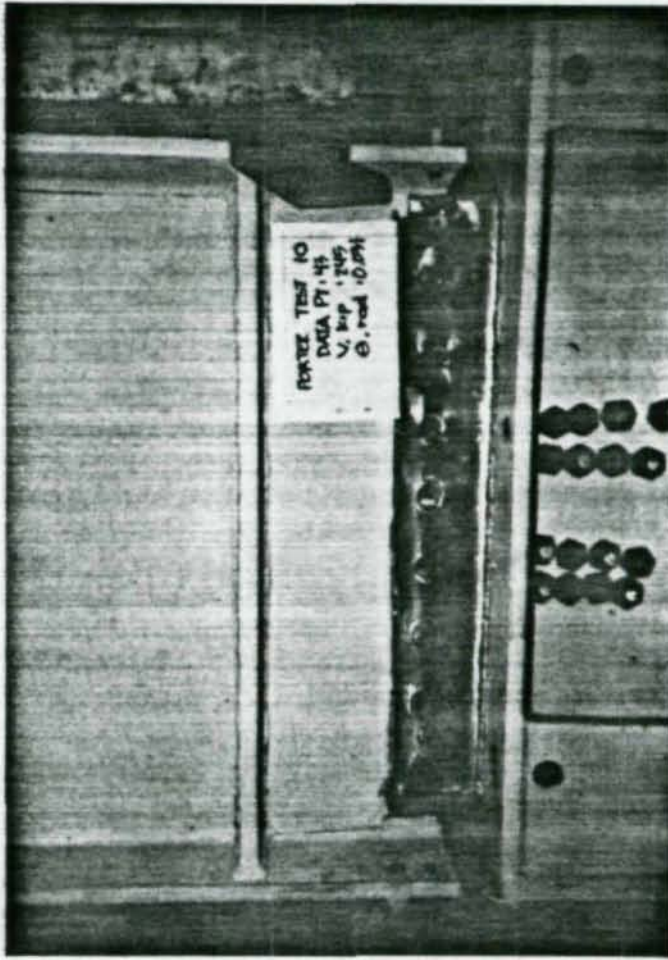

Figure 3-9: 9-bolt specimen at the end of test

3 - 3/4 diam A490 in SSH

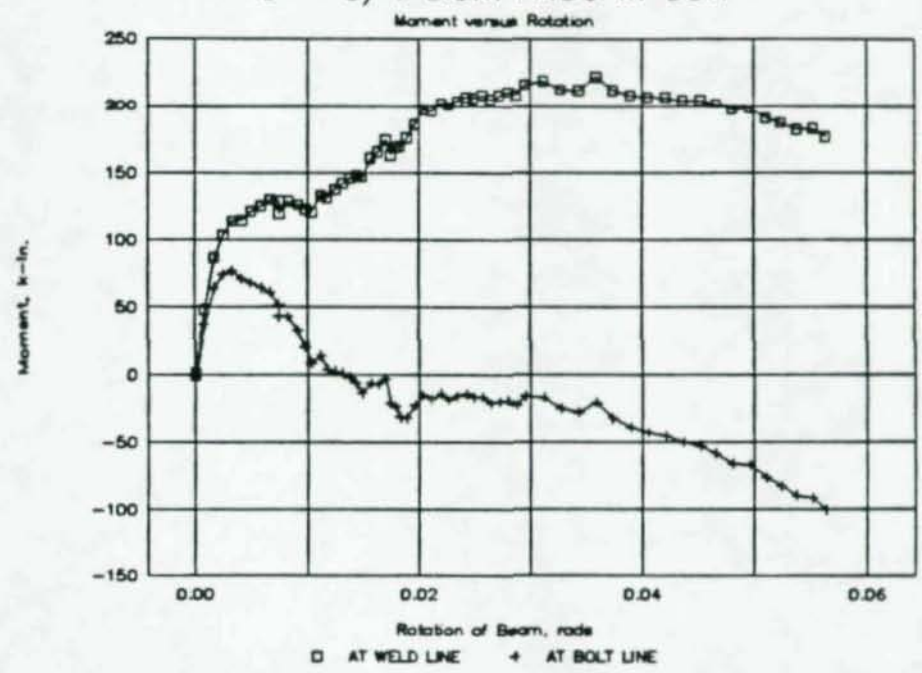

Figure 4-1: Moment-rotation behavior of 3-bolt specimen

5 - 3/4 diam A490 in SSH

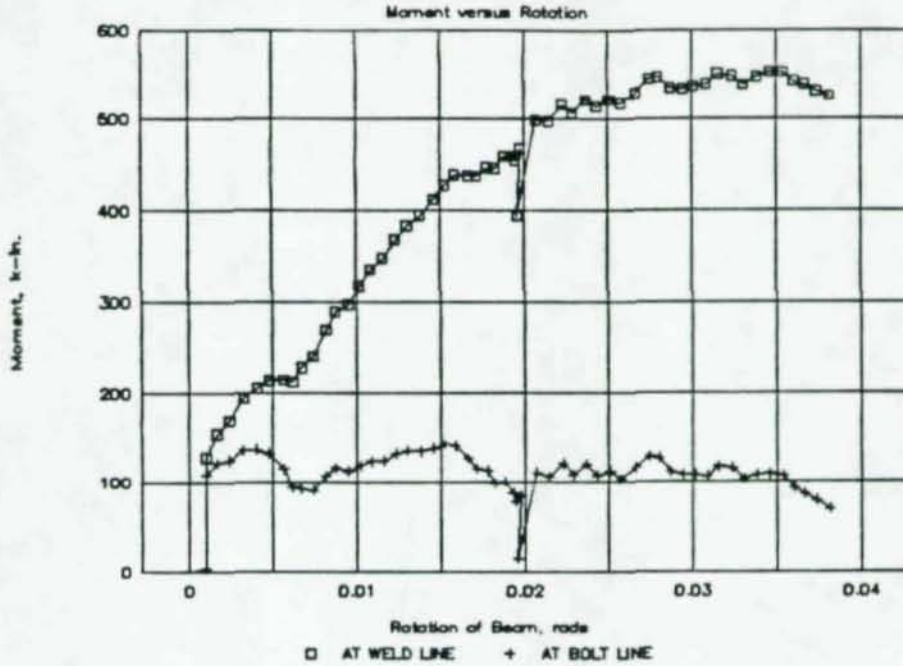

Figure 4-2: Moment-rotation behavior of 5-bolt specimen

7 - 3/4 diam A490 in SSH

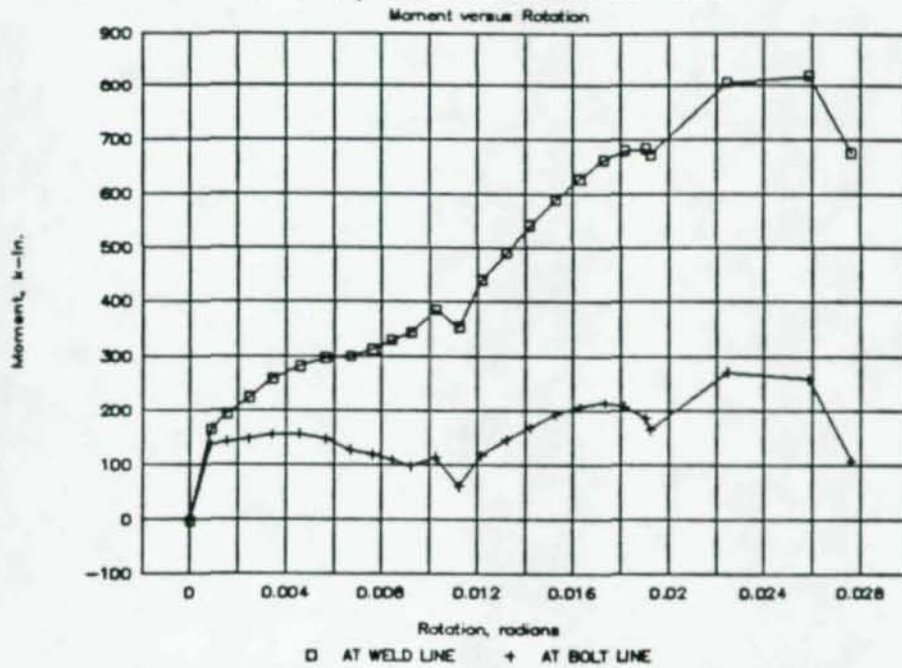

Figure 4-3: Moment-rotation behavior of 7-bolt specimen

9 - 3/4 diam A490 in SSH

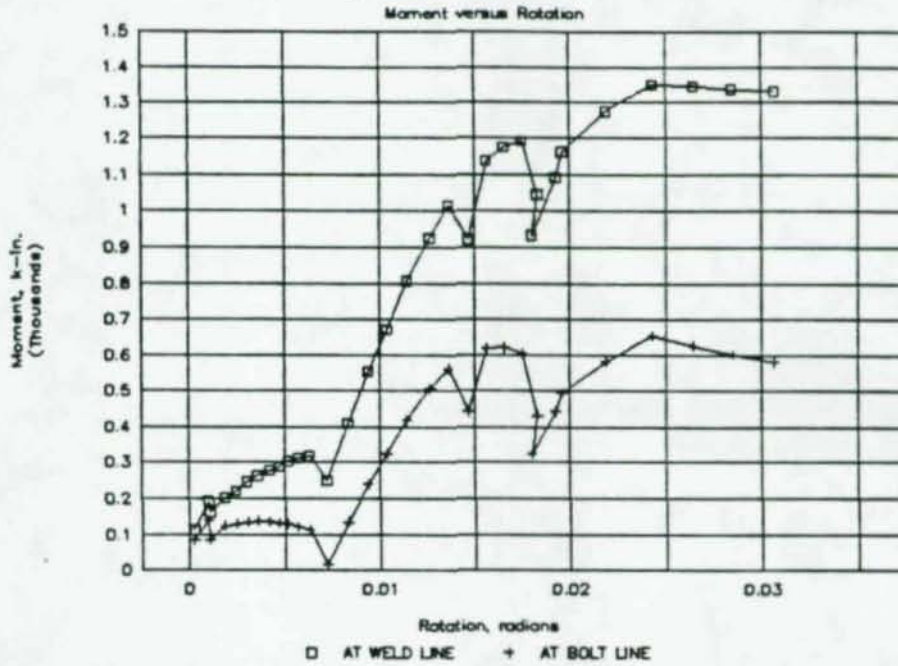

Figure 4-4: Moment-rotation behavior of 9-bolt specimen

3 - 3/4 diam A490 in SSH

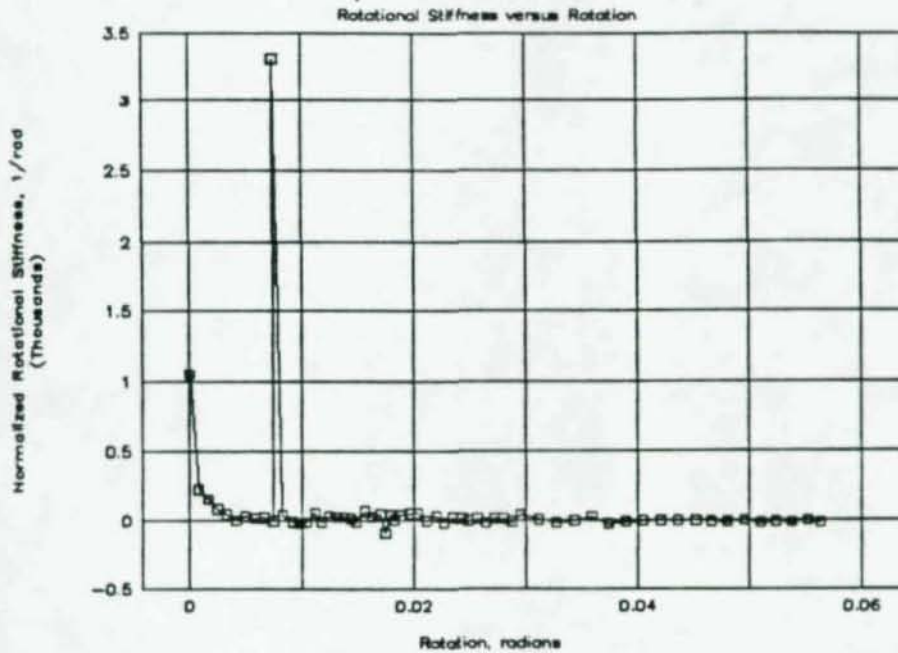

Figure 4-5: Rotational stiffness behavior of 3-bolt specimen

5 - 3/4 diam A490 in SSH

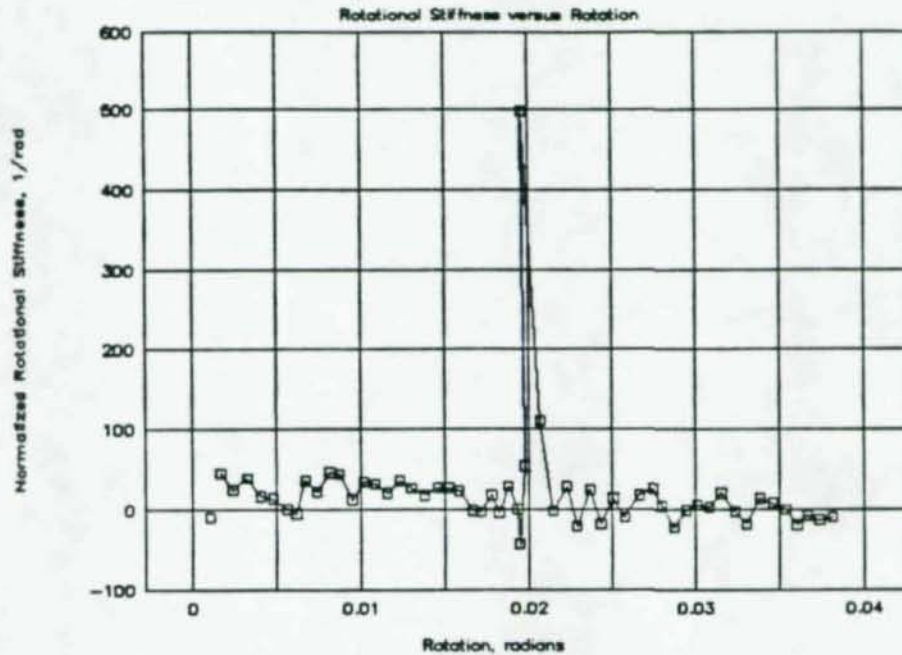

Figure 4-6: Rotational stiffness behavior of 5-bolt specimen

7 - 3/4 diam A490 in SSH

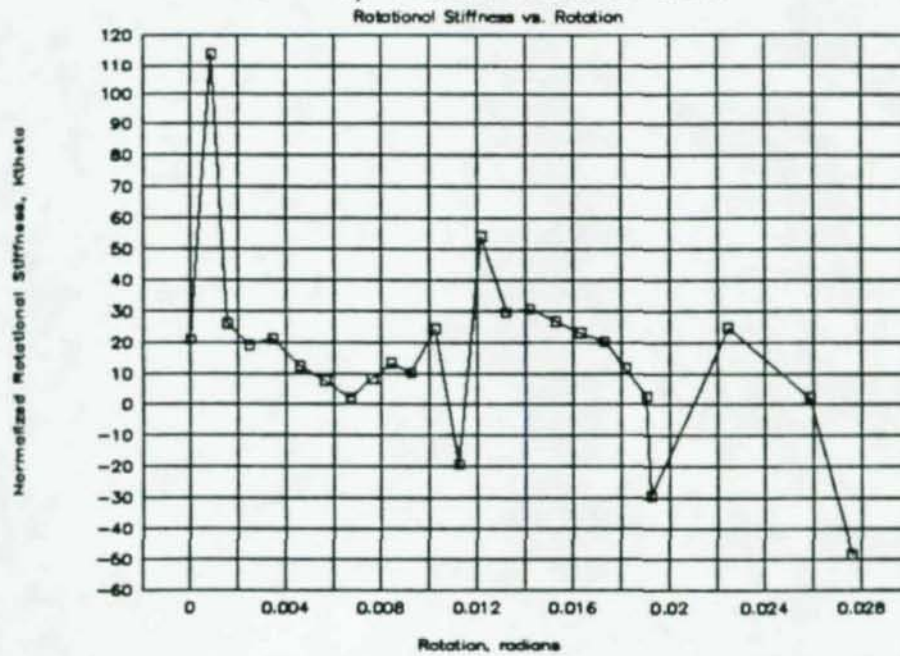

Figure 4-7: Rotational stiffness behavior of 7-bolt specimen

9 - 3/4 diam A490 in SSH
Rotational Stiffness vs. Rotation

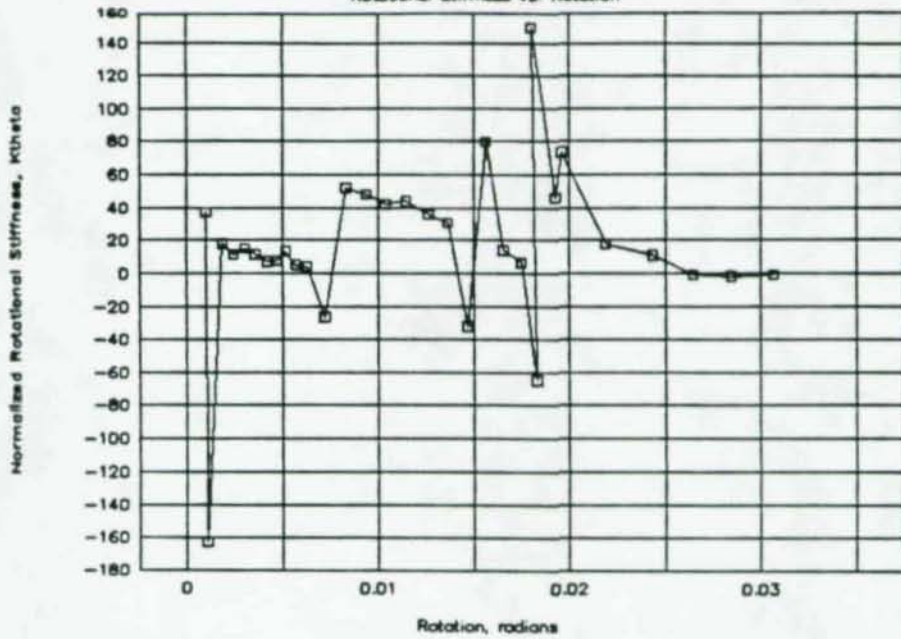

Figure 4-8: Rotational stiffness behavior of 9-bolt specimen

3 - 3/4 diam A490 in SSH
Location of Inflection Point

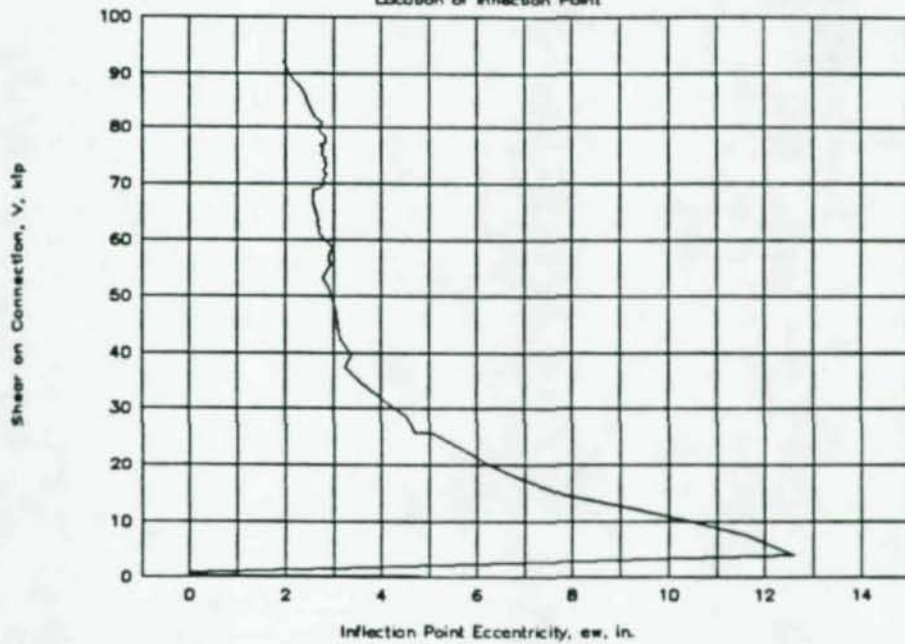

Figure 4-9: Reaction eccentricity behavior of 3-bolt specimen

5 - 3/4 diam A490 in SSH

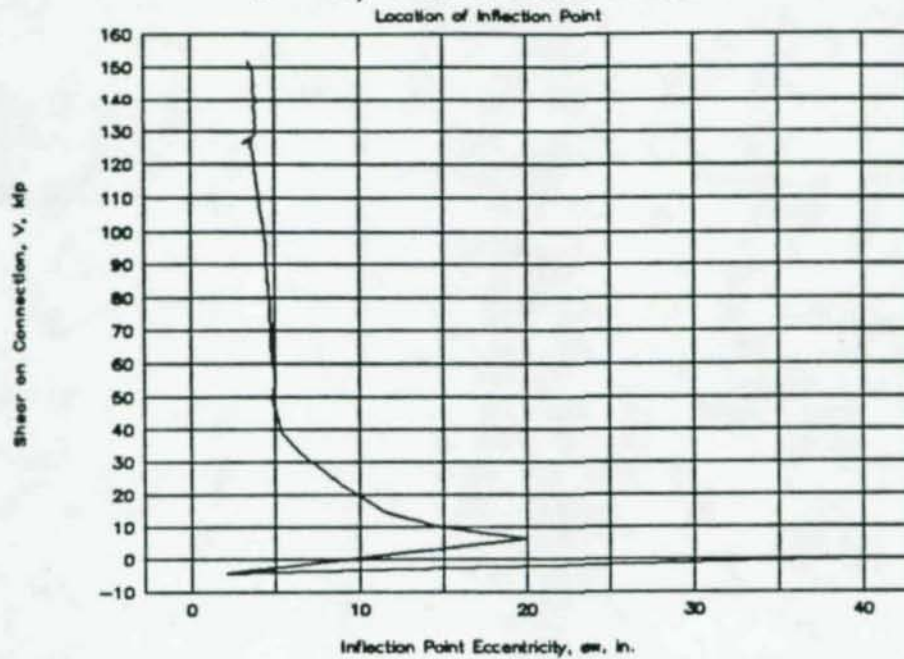

Figure 4-10: Reaction eccentricity behavior of 5-bolt specimen

7 - 3/4 diam A490 in SSH

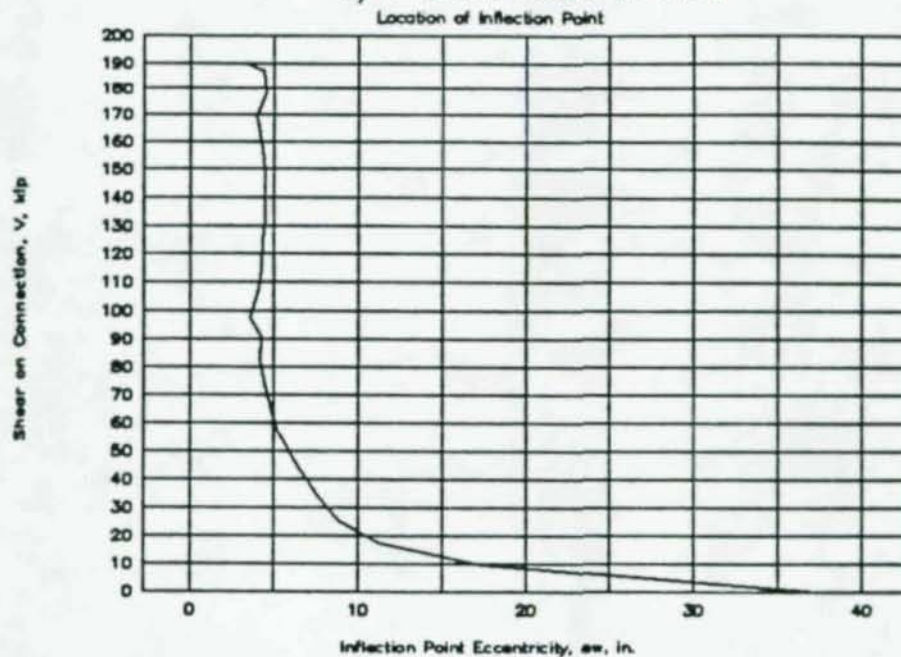

Figure 4-11: Reaction eccentricity behavior of 7-bolt specimen

9 - 3/4 diam A490 in SSH

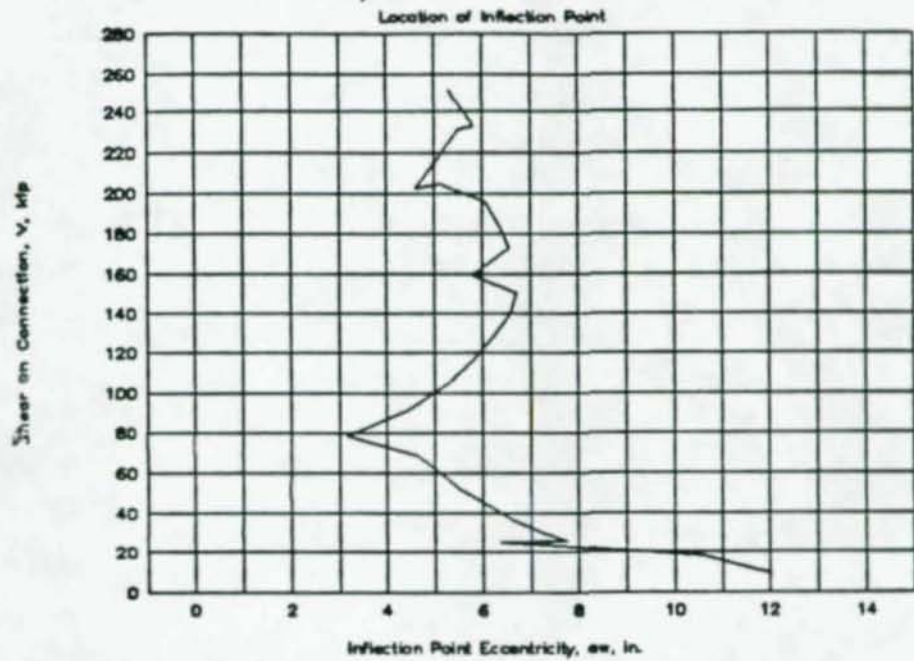

Figure 4-12: Reaction eccentricity behavior of 9-bolt specimen

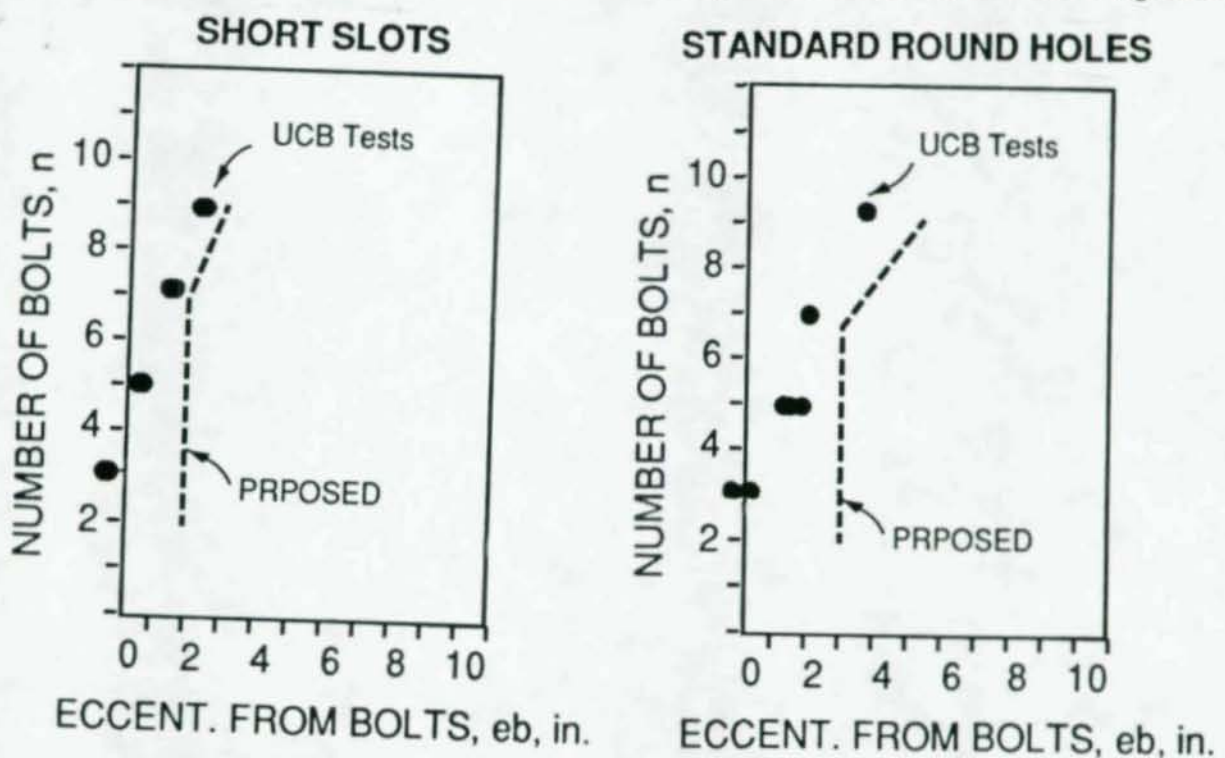

Figure 4-13: Eccentricity of point of inflection

- (a) Short slotted holes
- (b) Standard round holes

APPENDIX A

EXPERIMENTAL DATA

The experimental data collected during the tests are presented in this appendix. They are discussed in Chapters 3 and 4.

3 - 3/4 diam A490 in SSH
Load Path, Shear versus Rotation

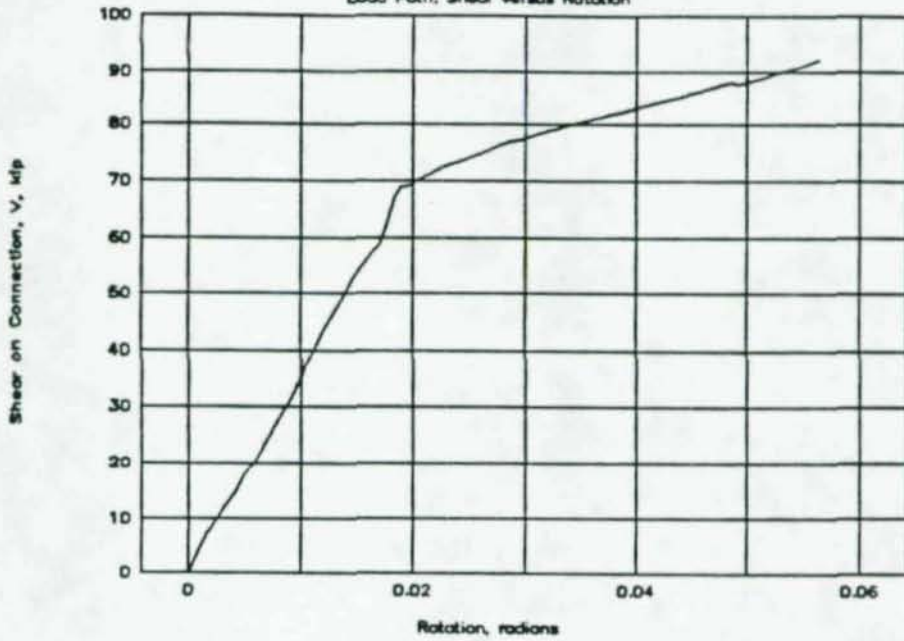

Figure A-1: Load path for 3-bolt specimen

5 - 3/4 diam A490 in SSH
Load Path, Shear versus Rotation

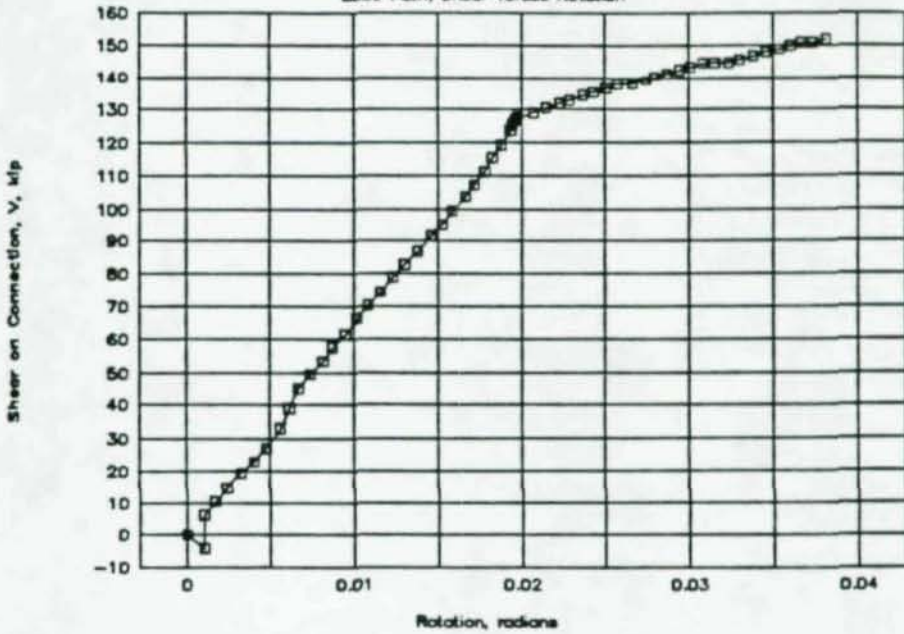

Figure A-2: Load path for 5-bolt specimen

7 - 3/4 diam A490 in SSH

Load Path, Shear versus Rotation

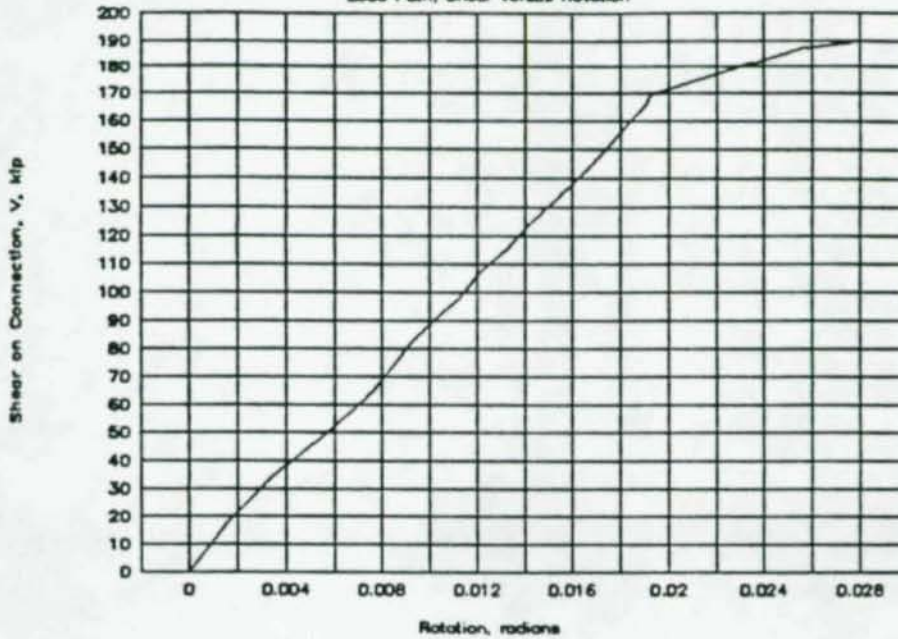

Figure A-3: Load path for 7-bolt specimen

9 - 3/4 diam A490 in SSH

Load Path, Shear versus Rotation



Figure A-4: Load path for 9-bolt specimen

3 - 3/4 diam A490 in SSH

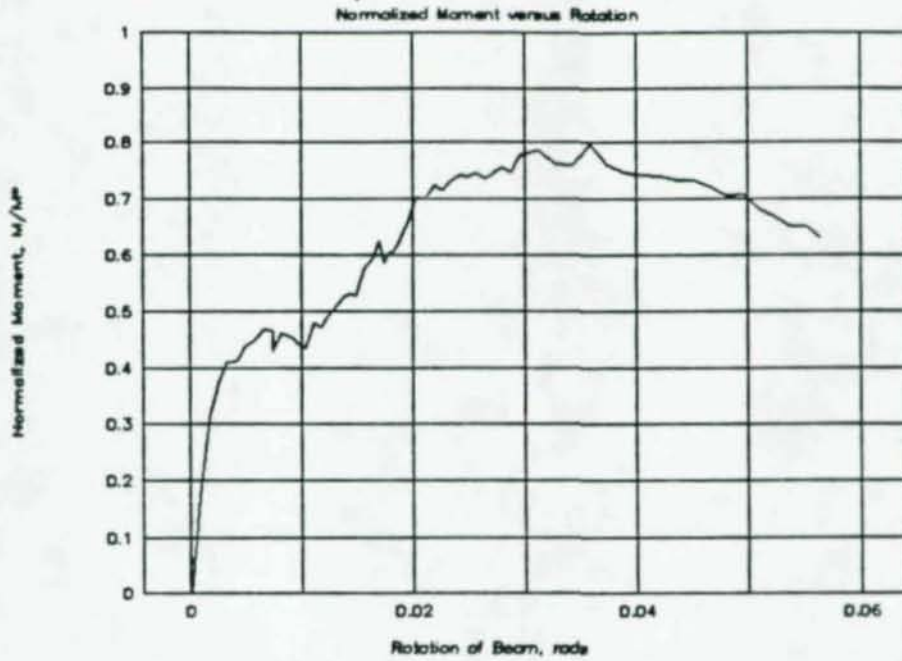

Figure A-5: Normalized moment versus rotation for 3-bolt specimen

5 - 3/4 diam A490 in SSH

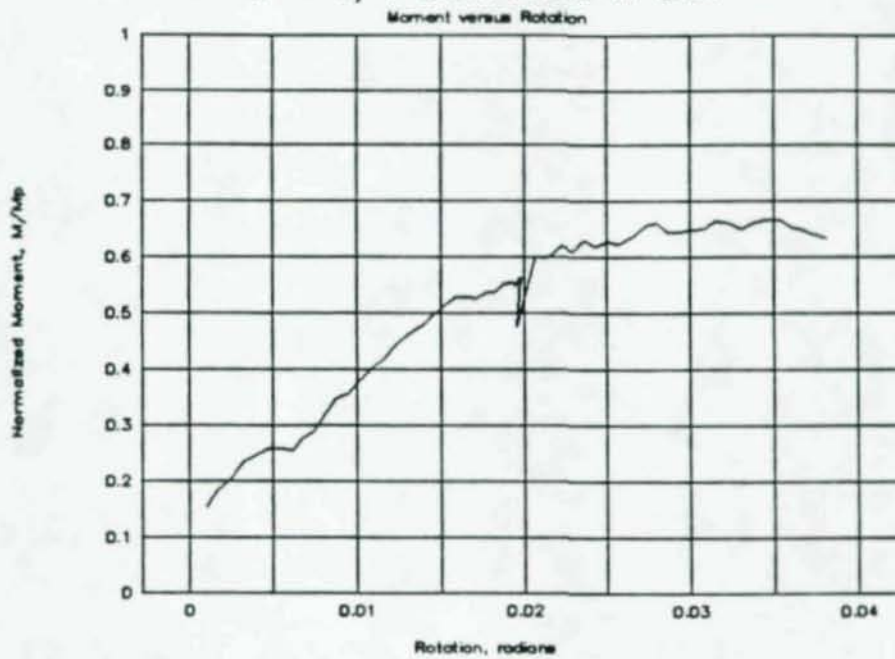

Figure A-6: Normalized moment versus rotation for 5-bolt specimen

7 - 3/4 diam A490 in SSH
Normalized Moment versus Rotation

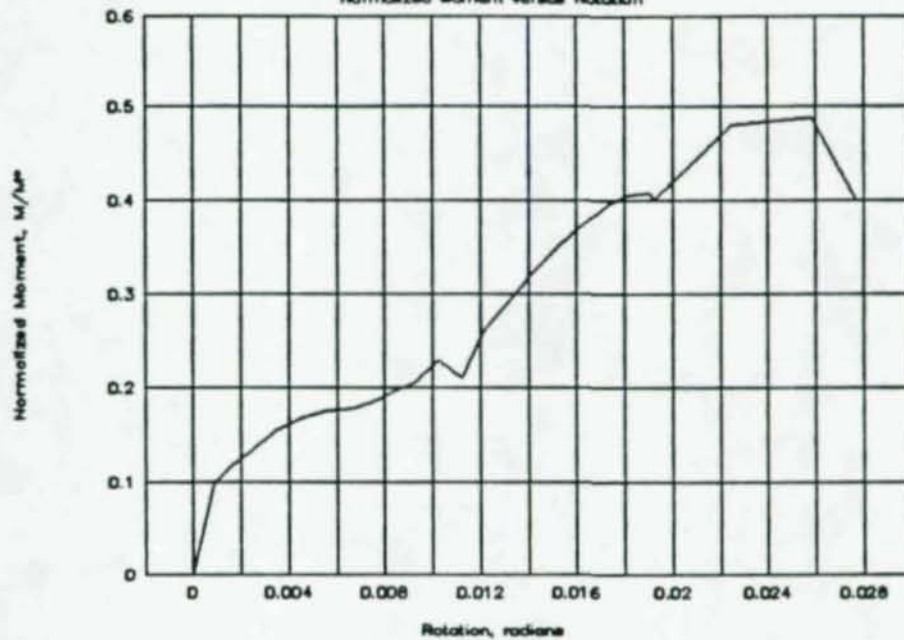

Figure A-7: Normalized moment versus rotation for 7-bolt specimen

9 - 3/4 diam A490 in SSH
Normalized Moment versus Rotation

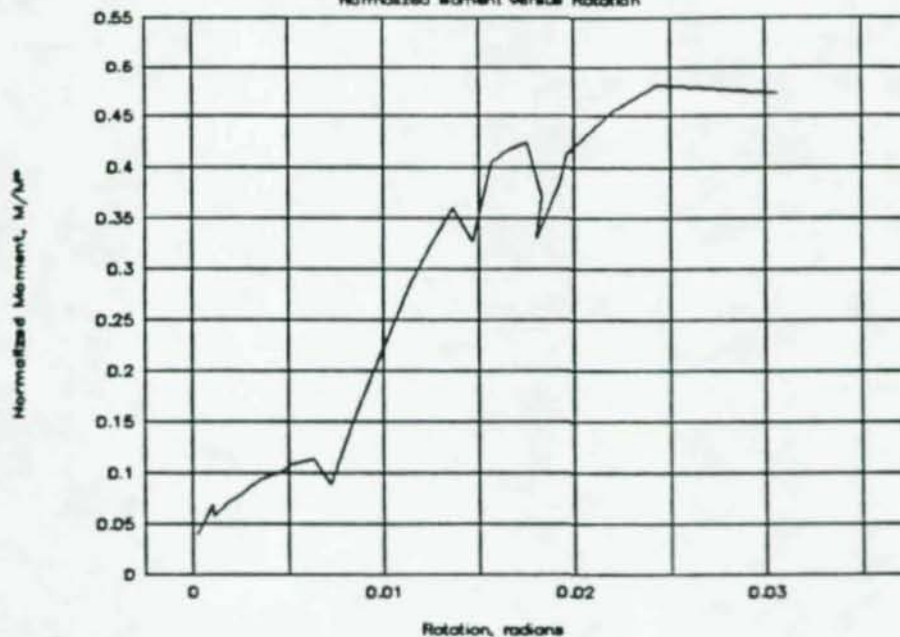

Figure A-8: Normalized moment versus rotation for 9-bolt specimen

3 - 3/4 diam A490 in SSH

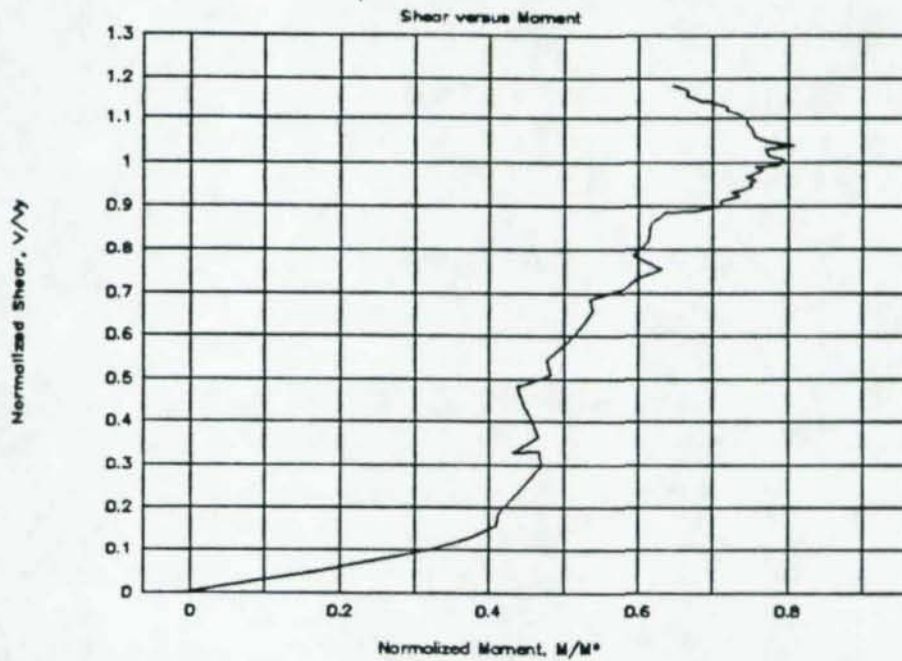

Figure A-9: Normalized shear-moment behavior for 3-bolt specimen

5 - 3/4 diam A490 in SSH

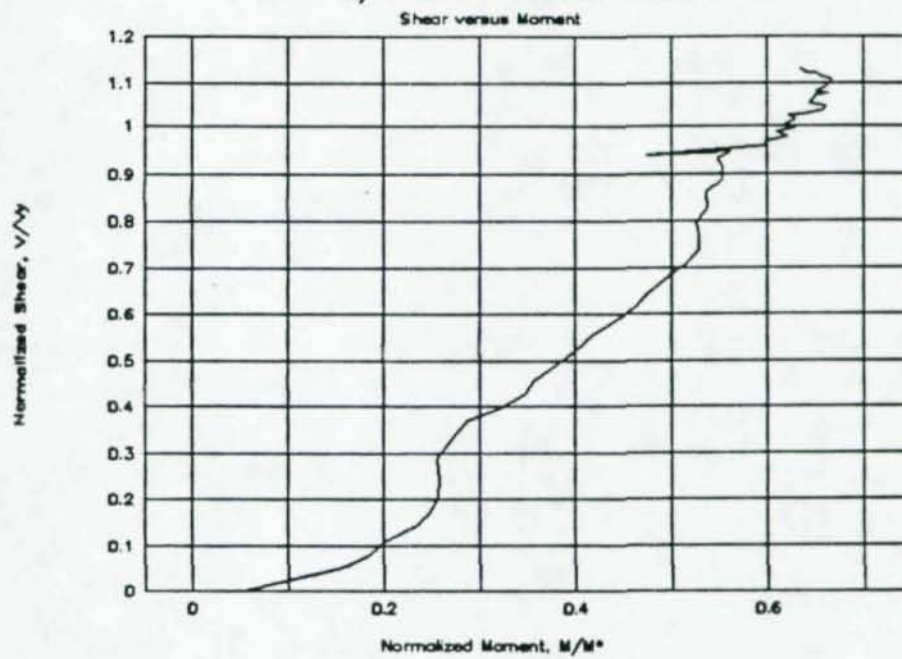

Figure A-10: Normalized shear-moment behavior for 5-bolt specimen

7 - 3/4 diam A490 in SSH

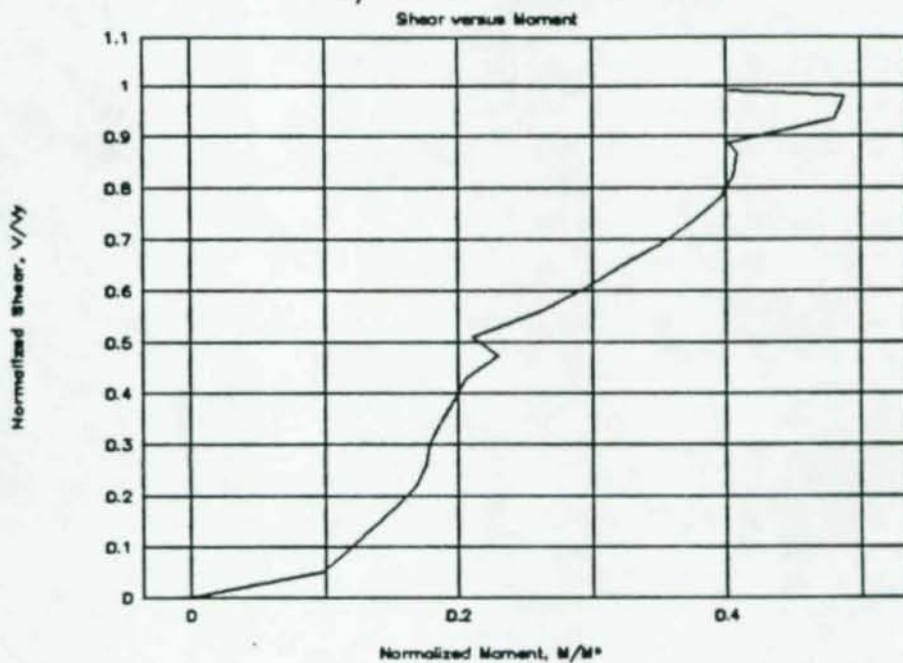

Figure A-11: Normalized shear-moment behavior for 7-bolt specimen

9 - 3/4 diam A490 in SSH

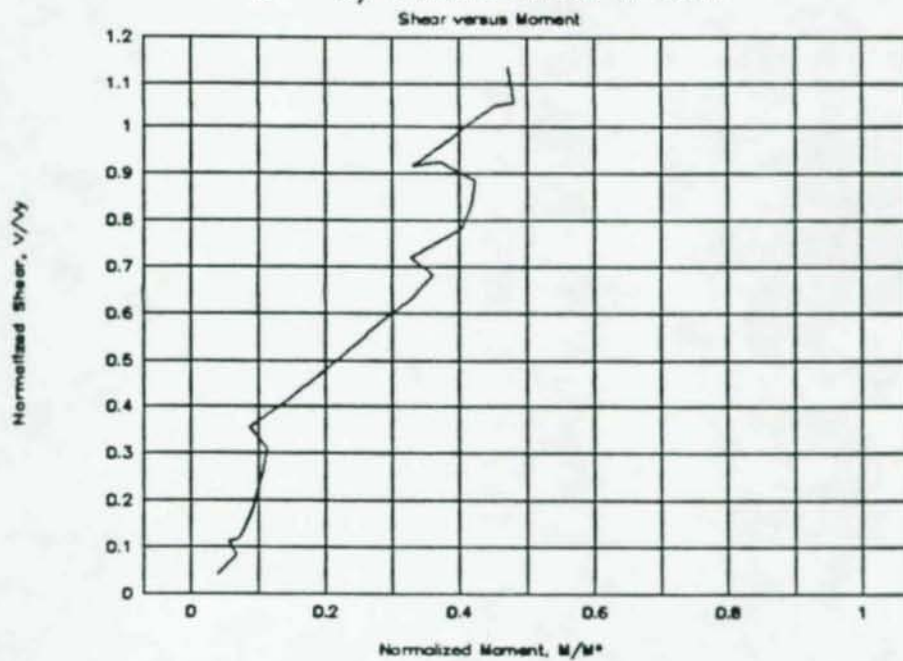

Figure A-12: Normalized shear-moment behavior for 9-bolt specimen

9/510

APPENDIX B

MATERIAL PROPERTIES

The results of the coupon tests of the plate material are presented in this appendix.

APPENDIX C

DESIGN TABLES

The design tables discussed in Chapter 6 are presented in this appendix.

61310

Table C-1: Design tables for 2-bolt and 3-bolt connections

SINGLE-PLATE SHEAR CONNECTIONS

TABLE X-I Allowable loads in kips

n = 2 L = 6

	Plate Thickness, <i>t</i> in.	Bolt Size, in.					
		3/8		1/2		1	
		Load	Weld	Load	Weld	Load	Weld
A325-N	1/4	10.9	3/16	14.9	3/16	16.9	3/16
	3/16	10.9	1/4	14.9	1/4	19.4	1/4
	3/8	10.9	3/16	14.9	3/16	19.4	3/16
	1/2	10.9	3/8	14.9	3/8	19.4	3/8
	5/8	—	—	14.9	3/8	19.4	3/8
	3/4	—	—	—	—	19.4	3/8
A490-N	1/4	14.6	3/16	17.9	3/16	16.9	3/16
	3/16	14.6	1/4	19.8	1/4	21.0	1/4
	3/8	14.6	3/16	19.8	3/16	25.2	3/16
	1/2	14.6	3/8	19.8	3/8	25.9	3/8
	5/8	—	—	19.8	3/8	25.9	3/8
	3/4	—	—	—	—	25.9	3/8

TABLE X-J Allowable loads in kips

n = 3 L = 9

	Plate Thickness, <i>t</i> in.	Bolt Size, in.					
		3/8		1/2		1	
		Load	Weld	Load	Weld	Load	Weld
A325-N	1/4	20.6	3/16	26.9	3/16	25.3	3/16
	3/16	20.6	1/4	28.1	1/4	31.6	1/4
	3/8	20.6	3/16	28.1	3/16	36.8	3/16
	1/2	20.6	3/8	28.1	3/8	36.8	3/8
	5/8	—	—	28.1	3/8	36.8	3/8
	3/4	—	—	—	—	36.8	3/8
A490-N	1/4	27.5	3/16	26.9	3/16	25.3	3/16
	3/16	27.5	1/4	33.6	1/4	31.6	1/4
	3/8	27.5	3/16	37.5	3/16	37.9	3/16
	1/2	27.5	3/8	37.5	3/8	44.2	3/8
	5/8	—	—	37.5	3/8	49.0	3/8
	3/4	—	—	—	—	49.0	3/8

Table C-2: Design tables for 4-bolt and 5-bolt connections

SINGLE-PLATE SHEAR CONNECTIONS

TABLE X-K Allowable loads in kips

n = 4 L = 12



	Plate Thickness, t in.	Bolt Size, in.					
		3/8		1/2		1	
		Load	Weld	Load	Weld	Load	Weld
A325- N	1/4	30.8	3/16	35.4	3/16	33.7	3/16
	3/16	30.8	1/4	41.9	1/4	42.1	1/4
	3/8	30.8	3/16	41.9	3/16	50.5	3/16
	1/2	30.8	3/8	41.9	3/8	54.7	3/8
	5/8	—	—	41.9	3/8	54.7	3/8
	3/4	—	—	—	—	54.7	3/16
A490- N	1/4	38.0	3/16	35.9	3/16	33.7	3/16
	3/16	41.0	1/4	44.9	1/4	42.1	1/4
	3/8	41.0	3/16	53.8	3/16	50.6	3/16
	1/2	41.0	3/8	55.9	3/8	60.0	3/8
	5/8	—	—	55.9	3/8	67.4	3/8
	3/4	—	—	—	—	73.0	3/16

TABLE X-L Allowable loads in kips

n = 5 L = 15



	Plate Thickness, t in.	Bolt Size, in.					
		3/8		1/2		1	
		Load	Weld	Load	Weld	Load	Weld
A325- N	1/4	40.8	3/16	44.9	3/16	42.1	3/16
	3/16	40.8	1/4	55.5	1/4	52.7	1/4
	3/8	40.8	3/16	55.5	3/16	63.2	3/16
	1/2	40.8	3/8	55.5	3/8	72.5	3/8
	5/8	—	—	55.5	3/8	72.5	3/8
	3/4	—	—	—	—	72.5	3/16
A490- N	1/4	47.6	3/16	44.9	3/16	42.1	3/16
	3/16	54.4	1/4	56.1	1/4	52.7	1/4
	3/8	54.4	3/16	67.3	3/16	63.2	3/16
	1/2	54.4	3/8	74.1	3/8	73.7	3/8
	5/8	—	—	74.1	3/8	84.3	3/8
	3/4	—	—	—	—	94.8	3/16

Table C-3: Design tables for 6-bolt and 7-bolt connections

SINGLE-PLATE SHEAR CONNECTIONS

TABLE X-M Allowable loads in kips

n = 6 L = 18

	Plate Thickness, <i>t</i> in.	Bolt Size, in.					
		$\frac{1}{2}$		$\frac{3}{4}$		1	
		Load	Weld	Load	Weld	Load	Weld
A325- N	$\frac{1}{4}$	50.6	$\frac{3}{16}$	53.8	$\frac{3}{16}$	50.6	$\frac{3}{16}$
	$\frac{3}{16}$	50.6	$\frac{1}{4}$	67.3	$\frac{1}{4}$	63.2	$\frac{1}{4}$
	$\frac{1}{2}$	50.6	$\frac{3}{16}$	68.8	$\frac{3}{16}$	75.9	$\frac{3}{16}$
	$\frac{3}{8}$	50.6	$\frac{1}{2}$	48.8	$\frac{1}{2}$	88.5	$\frac{1}{2}$
	$\frac{1}{2}$	—	—	68.8	$\frac{3}{4}$	89.9	$\frac{3}{4}$
	$\frac{3}{4}$	—	—	—	—	89.9	$\frac{1}{2}$
A490- N	$\frac{1}{4}$	57.1	$\frac{3}{16}$	53.8	$\frac{3}{16}$	50.6	$\frac{3}{16}$
	$\frac{3}{16}$	67.4	$\frac{1}{4}$	67.3	$\frac{1}{4}$	63.2	$\frac{1}{4}$
	$\frac{1}{2}$	67.4	$\frac{3}{16}$	80.7	$\frac{3}{16}$	75.9	$\frac{3}{16}$
	$\frac{3}{8}$	67.4	$\frac{1}{2}$	91.8	$\frac{1}{2}$	88.5	$\frac{1}{2}$
	$\frac{1}{2}$	—	—	91.8	$\frac{3}{4}$	101	$\frac{3}{4}$
	$\frac{3}{4}$	—	—	—	—	101	$\frac{1}{2}$

TABLE X-N Allowable loads in kips

n = 7 L = 21

	Plate Thickness, <i>t</i> in.	Bolt Size, in.					
		$\frac{1}{2}$		$\frac{3}{4}$		1	
		Load	Weld	Load	Weld	Load	Weld
A325- N	$\frac{1}{4}$	60.1	$\frac{3}{16}$	62.8	$\frac{3}{16}$	59.0	$\frac{3}{16}$
	$\frac{3}{16}$	60.1	$\frac{1}{4}$	78.5	$\frac{1}{4}$	73.7	$\frac{1}{4}$
	$\frac{1}{2}$	60.1	$\frac{3}{16}$	81.8	$\frac{3}{16}$	88.5	$\frac{3}{16}$
	$\frac{3}{8}$	60.1	$\frac{1}{2}$	81.8	$\frac{1}{2}$	103	$\frac{1}{2}$
	$\frac{1}{2}$	—	—	81.8	$\frac{3}{4}$	107	$\frac{3}{4}$
	$\frac{3}{4}$	—	—	—	—	107	$\frac{1}{2}$
A490- N	$\frac{1}{4}$	66.6	$\frac{3}{16}$	62.8	$\frac{3}{16}$	59.0	$\frac{3}{16}$
	$\frac{3}{16}$	80.2	$\frac{1}{4}$	78.5	$\frac{1}{4}$	73.7	$\frac{1}{4}$
	$\frac{1}{2}$	80.2	$\frac{3}{16}$	94.2	$\frac{3}{16}$	88.5	$\frac{3}{16}$
	$\frac{3}{8}$	80.2	$\frac{1}{2}$	109	$\frac{1}{2}$	103	$\frac{1}{2}$
	$\frac{1}{2}$	—	—	109	$\frac{3}{4}$	118	$\frac{3}{4}$
	$\frac{3}{4}$	—	—	—	—	133	$\frac{1}{2}$

Table C-4: Design tables for 8-bolt and 9-bolt connections

SINGLE-PLATE SHEAR CONNECTIONS

TABLE X-0 Allowable loads in kips

n = 8 L = 24

	Plate Thickness, t in.	Bolt Size, in.					
		3/8		1/2		1	
		Load	Weld	Load	Weld	Load	Weld
A325-N	1/4	68.8	3/16	71.7	3/16	67.4	3/16
	3/16	68.8	1/4	89.7	1/4	84.2	1/4
	1/8	68.8	3/16	93.7	3/16	101	3/16
	3/16	68.8	1/2	93.7	1/2	118	1/2
	1/2	—	—	93.7	3/4	122	3/4
	3/4	—	—	—	—	122	1/16
A490-N	1/4	76.1	3/16	71.7	3/16	67.4	3/16
	3/16	91.8	1/4	89.7	1/4	84.2	1/4
	1/8	91.8	3/16	108	3/16	101	3/16
	3/16	91.8	1/2	125	1/2	118	1/2
	1/2	—	—	125	3/4	135	3/4
	3/4	—	—	—	—	152	1/16

TABLE X-P Allowable loads in kips

n = 9 L = 27

	Plate Thickness, t in.	Bolt Size, in.					
		3/8		1/2		1	
		Load	Weld	Load	Weld	Load	Weld
A325-N	1/4	75.8	3/16	80.7	3/16	75.9	3/16
	3/16	75.8	1/4	101	1/4	94.8	1/4
	1/8	75.8	3/16	103	3/16	114	3/16
	3/16	75.8	1/2	103	1/2	133	1/2
	1/2	—	—	103	3/4	135	3/4
	3/4	—	—	—	—	135	1/16
A490-N	1/4	85.6	3/16	80.7	3/16	75.9	3/16
	3/16	101	1/4	101	1/4	101	1/4
	1/8	101	3/16	121	3/16	114	3/16
	3/16	101	1/2	137	1/2	133	1/2
	1/2	—	—	137	3/4	152	3/4
	3/4	—	—	—	—	171	1/16

01652

APPENDIX D

TEST SUMMARY SHEETS

This appendix summarizes properties of the test specimens and provides brief summary of the test observations. The information is provided in a tabulated format.

AISC SINGLE PLATE FRAMING CONNECTION

SUMMARY OF TEST ON 3-BOLT CONNECTION

OBJECTIVE: To study actual behavior of single plate framing connection with snug-tight bolts and short slotted holes.

TEST DATE: 16 June 1989

CONDUCTED BY: A. Astaneh-Asl, K. Porter, R. Stephen

LABORATORY: 200 Davis Hall, University of California, Berkeley

PROPERTIES OF TEST SPECIMEN:

PLATE DEPTH: 8-1/4" PL. WIDTH: 4-1/4" PL. THICKNESS: 3/8"

PLATE F_y : 43.6 ksi PL. F_u : 62.9 ksi PL. MATERIAL: A36

NUMBER OF BOLTS: 3 BOLT DIAM: 3/4" BOLT TYPE: A490-N

HOLE DIAM: 13/16" EDGE DIST: 1-1/8" HOLE TYPE: SHORT SLOTTED

WELD SIZE: 1/4" WELD LENGTH: 8-1/4" WELD ELECTRODE: E70XX

EXPECTED SHEAR CAPACITY R_y : 77.8 kip

TEST RESULTS:

MAXIMUM SHEAR: 92.1 kip AT ROTATION: 0.0565 radians

FAILURE MODE: Top bolts suddenly sheared off, bottom bolt sliced through plate.

GENERAL COMMENTS AND DISCUSSION:

- Shear yield patterns appeared at 0.0189 rad.
- Shear yield patterns along most of plate length by 0.0204 rad. and 70.9 kip
- Shear yield patterns along entire plate length by 0.0297 rad. and 77.5 kip
- Fracture at 0.0565 radians, 92.1 kip.

55910

AISC SINGLE PLATE FRAMING CONNECTION

SUMMARY OF TEST ON 5-BOLT CONNECTION

OBJECTIVE: To study actual behavior of single plate framing connection with snug-tight bolts and short slotted holes.

TEST DATE: 2 May 1989

CONDUCTED BY: A. Astaneh-Asl, S. Call, K. Porter, R. Stephen

LABORATORY: 200 Davis Hall, University of California, Berkeley

PROPERTIES OF TEST SPECIMEN:

PLATE DEPTH: 14.25" PL. WIDTH: 4-1/4" PL. THICKNESS: 3/8"

PLATE F_y : 43.6 ksi PL. F_u : 62.9 ksi PL. MATERIAL: A36

NUMBER OF BOLTS: 5 BOLT DIAM: 3/4" BOLT TYPE: A490-N

HOLE DIAM: 13/16" EDGE DIST: 1-1/8" HOLE TYPE: SHORT SLOTTED

WELD SIZE: 1/4" WELD LENGTH: 14.25" WELD ELECTRODE: E70XX

EXPECTED SHEAR CAPACITY R_y : 134.4 kip

TEST RESULTS:

MAXIMUM SHEAR: 151.9 kip AT ROTATION: 0.038 radians

FAILURE MODE: All bolts suddenly sheared off.

GENERAL COMMENTS AND DISCUSSION:

- Shear yield patterns along almost entire length of plate, except top and bottom 1-1/2 in., at 0.0178 rad. and 107 kip
- Shear yield patterns along entire plate length by 0.020 rad. and 120 kip.
- Fracture at 0.038 rad. and 151.9 kip

95910
01656

AISC SINGLE PLATE FRAMING CONNECTION

SUMMARY OF TEST ON 7-BOLT CONNECTION

OBJECTIVE: To study actual behavior of single plate framing connection with snug-tight bolts and short slotted holes.

TEST DATE: 6 April 1990

CONDUCTED BY: A. Astaneh-Asl, W. McCracken, K. Porter, and R. Stephen

LABORATORY: 200 Davis Hall, University of California, Berkeley

PROPERTIES OF TEST SPECIMEN:

PLATE DEPTH: 20.25" PL. WIDTH: 4-1/4" PL. THICKNESS: 3/8"

PLATE F_y : 43.6 ksi PL. F_u : 62.9 ksi PL. MATERIAL: A36

NUMBER OF BOLTS: 7 BOLT DIAM: 3/4" BOLT TYPE: A490-N

HOLE DIAM: 13/16" EDGE DIST: 1-1/8" HOLE TYPE: SHORT SLOTTED

WELD SIZE: 1/4" WELD LENGTH: 20.25" WELD ELECTRODE: E70XX

EXPECTED SHEAR CAPACITY R_y : 191.0 kip

TEST RESULTS:

MAXIMUM SHEAR: 189 kip AT ROTATION: 0.030 radians

FAILURE MODE: All bolts suddenly sheared off.

GENERAL COMMENTS AND DISCUSSION:

- Bearing yield patterns appeared below bolts at 0.008 rad. and 68 kips.
- Shear yield patterns appeared at 0.0178 rad. and 152 kips.
- Shear yield patterns along almost entire plate length, at 0.019 rad. and 169 kips.
- Fracture at 0.030 rad. and 189 kips.

01657

AISC SINGLE PLATE FRAMING CONNECTION

SUMMARY OF TEST ON 9-BOLT CONNECTION

OBJECTIVE: To study actual behavior of single plate framing connection with snug-tight bolts and short slotted holes.

TEST DATE: 5 March 1990

CONDUCTED BY: A. Astaneh-Asl, K. Porter, R. Stephen

LABORATORY: 200 Davis Hall, University of California, Berkeley

PROPERTIES OF TEST SPECIMEN:

PLATE DEPTH: 26.25" PL. WIDTH: 4-1/4" PL. THICKNESS: 3/8"

PLATE F_y : 43.6 ksi PL. F_u : 62.9 ksi PL. MATERIAL: A36

NUMBER OF BOLTS: 3 BOLT DIAM: 3/4" BOLT TYPE: A490-N

HOLE DIAM: 13/16" EDGE DIST: 1-1/8" HOLE TYPE: SHORT SLOTTED

WELD SIZE: 1/4" WELD LENGTH: 26.25" WELD ELECTRODE: E70XX

EXPECTED SHEAR CAPACITY R_y : 248 kip

TEST RESULTS:

MAXIMUM SHEAR: 250.8 kip AT ROTATION: 0.0345 radians

FAILURE MODE: All bolts suddenly sheared off.

GENERAL COMMENTS AND DISCUSSION:

- Yield patterns appeared below bolts at 0.010 rad., 111 kip.
- Shear yield patterns along bottom 19 in. of plate length at 0.0175 rad., 193 kip.
- Shear yield patterns along entire plate except top 1-1/2 in., by 0.0243 rad. and 233 kip.
- Fracture at 0.0345 rad., 250.8 kip. There was a fracture in the plate along the top 2-1/2 inches of plate near the weld line. No shear yield patterns at top 1-1/8 in. of plate.

